

**FAG****UC213**

## Radial insert ball bearing

Materiálové číslo Schaeffler:  
0767500430000

Radial insert ball bearings UC, spherical  
outer ring, location by grub screws, RSR  
seals on both sides

## Technické informace

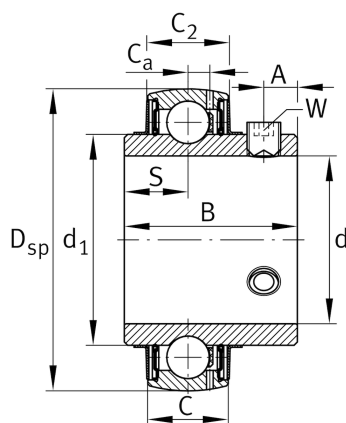
**Main Dimensions & Performance Data**

d	65 mm	Bore diameter
D <sub>SP</sub>	120 mm	Outside diameter
B	65,1 mm	Width
C <sub>r</sub>	61.000 N	Basic dynamic load rating, radial
C <sub>0r</sub>	40.000 N	Basic static load rating, radial
C <sub>ur</sub>	2.090 N	Fatigue load limit, radial
	1,72 kg	Hmotnost

**Dimensions**

C	28 mm	Width, outer ring
C <sub>2</sub>	29,4 mm	Sealing total width
S	25,4 mm	Distance raceway
d <sub>1</sub>	80,85 mm	Rib diameter inner ring
C <sub>a</sub>	8,2 mm	Distance to lubrication hole
A	12 mm	Distance thread
W	6 mm	Width of flats

**Calculation factors**

f <sub>0</sub>	14,4	Calculation factor
----------------	------	--------------------