

DICHTOMATIK

O-Rings





DICHTOMATIK

O-Rings

Albert-Schweitzer-Ring 1
D-22045 Hamburg
P.O. Box 70 04 80
D-22004 Hamburg
Phone 040/66 98 90
Fax 040/66 98 91 01
mail@dichtomatik.de
www.dichtomatik.de



DIN EN ISO 9001:2000

Contents

Dichtomatik	5
Dichtomatik in the Internet	6
O-rings	9
Quality assurance information (measuring aids, procedures)	11
Materials	12
Standard elastomers	13
Special elastomers	16
Surface treatments and antifriction	18
Material approval	18
Terms from the materials data sheet	20
Installation housings and design recommendations:	
Static sealing	24
Dynamic sealing	34
Design guidelines	38
Layout guidelines	40
General installation instructions	41
Back-up rings	42
Standard dimensions:	44
British Standard BS 1806 American Standard AS 568 A	44
British Standard metric BS 4518	46
French Standard R	48
Swedish Standard SMS 1586	49
Japanese Standard JIS 240 P+G	50
DIN 3771	52
ISO 3601-1 Series G	54
ISO 3601-1 Series A	56
Dichtomatik dimensions	58
Subsidiaries	109

Dichtomatik

Dichtomatik is a company that specialises in technical seals for every application and is renowned for keeping stocks of every kind of standard design, material and size. A highly developed sales organisation guarantees the fastest deliveries, anywhere in the world.

Their collective experience together with Dichtomatik's capabilities ensures that customers have the best possible technical support. This service is provided throughout Dichtomatik's world-wide network with subsidiaries currently in England, Austria, Holland, Sweden, Italy, France, Hungary, the USA and Canada and several offices in Asia.

Special orders, such as those designed and specified by Dichtomatik engineers in conjunction with the customer's designers on the one hand and the supplier's production engineers on the other, are the order of the day.

As a leading customer of its suppliers, our requirements for a fully functioning quality assurance system, materials and product design set the standard.

The product specification is the basis for every order for Dichtomatik seals. It contains the main quality features, the relevant standards, and any specific product requirements. It also contains details of the type and scope of any checks and other information, such as identification and packaging.

For safety reasons, Dichtomatik carries out random in-house checks on all received goods, the frequency and depth of which is determined by the classification of the relevant supplier. This ensures that every Dichtomatik product is of the same unchanging reliability.



Dichtomatik in the Internet

www.dichtomatik.de

The information in this catalogue and the technical data for every single standard Dichtomatik item is also accessible through the Internet. Anyone can find out anything they want to know about us, contact us, send an enquiry, look at our warehouse and check the availability of individual items. And send an order, of course.

In order to gain maximum benefit from Dichtomatik's service when ordering, the prices listed in the Internet are protected against abuse. We issue a secret password to every interested Dichtomatik customer, which can then be used in conjunction with the customer number to access our prices. For example, the valid net prices are automatically displayed when a warehouse enquiry is given. And the next step is the order!

You can reach Dichtomatik from anywhere in the world. At any time.

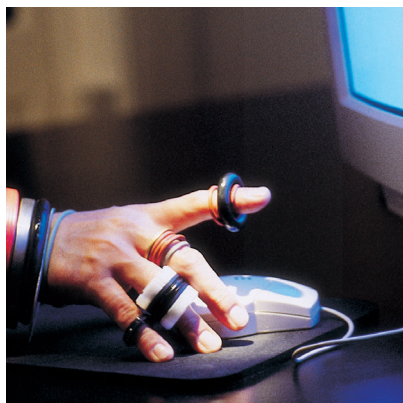

O-rings

O-rings are closed circular sealing elements. The way they work is based on deformation of the cross section. They are made through vulcanisation from form tools as a complete ring.

The simplicity of the shape of an O-ring and the reliability of its function is ingenious, and that is why they are the most frequently used type of seal. They are also economical to manufacture and easy to fit, which makes them unbeatable.

The O-ring designation is given from the dimension of its inner diameter and the cross section thickness in mm, the name of the material and its hardness (elasticity)

e.g. 25 x 1.5 NBR 70

Mode of operation

The sealing function of the installed O-ring is achieved by compression between two or more elements in the sealing gland groove.

When ready to operate, the medium pressure promotes the deformation and increases the sealing effectivity. If the pressure drops to "zero", the deformation reverts almost to the fitted state.

Applications

We differentiate between the static sealing of non-moving or dynamic sealing in moving machine elements. You will find further details in the chapter entitled "Installation spaces and structural recommendations" on page 24.

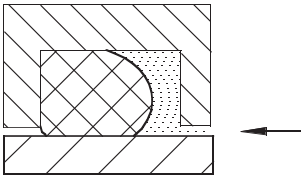
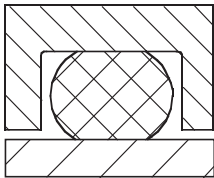
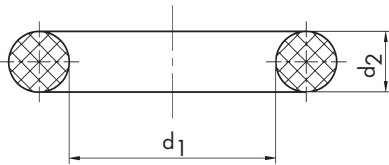

Dimensions and tolerances

Basic tolerances for O-rings
DIN ISO 3601 and DIN 3771

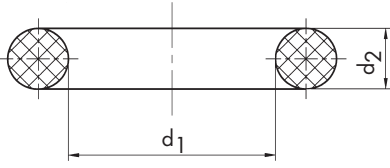

d 1	Tol	d 1	Tol	d 1	Tol
≤ 2.5	± 0.13	75	± 0.66	272	± 2.02
4.5	± 0.14	77.5	± 0.67	280	± 2.08
6.3	± 0.15	80	± 0.69	290	± 2.14
8.5	± 0.16	82.5	± 0.71	300	± 2.21
10.0	± 0.17	85	± 0.73	307	± 2.25
11.2	± 0.18	87.5	± 0.75	315	± 2.3
14	± 0.19	90	± 0.77	325	± 2.37
16	± 0.2	92.5	± 0.79	335	± 2.43
18	± 0.21	95	± 0.81	345	± 2.49
20	± 0.22	97.5	± 0.83	355	± 2.56
21.2	± 0.23	100	± 0.84	365	± 2.62
23.6	± 0.24	103	± 0.87	375	± 2.68
25	± 0.25	106	± 0.89	387	± 2.76
26.5	± 0.26	109	± 0.91	400	± 2.84
28	± 0.28	112	± 0.93	412	± 2.91
30	± 0.29	115	± 0.95	425	± 2.99
31.5	± 0.31	118	± 0.97	437	± 3.07
33.5	± 0.32	122	± 1	450	± 3.15
34.5	± 0.33	125	± 1.03	462	± 3.22
35.5	± 0.34	128	± 1.05	475	± 3.3
36.5	± 0.35	132	± 1.08	487	± 3.37
37.5	± 0.36	136	± 1.1	500	± 3.45
38.7	± 0.37	140	± 1.13	515	± 3.54
40	± 0.38	145	± 1.17	530	± 3.63
41.2	± 0.39	150	± 1.2	545	± 3.72
42.5	± 0.4	155	± 1.24	560	± 3.81
43.7	± 0.41	160	± 1.27	580	± 3.93
45	± 0.42	165	± 1.31	600	± 4.05
46.2	± 0.43	170	± 1.34	615	± 4.13
47.5	± 0.44	175	± 1.38	630	± 4.22
48.7	± 0.45	180	± 1.41	650	± 4.34
50	± 0.46	185	± 1.44	670	± 4.46
51.5	± 0.47	190	± 1.48	>670	± 0.7%
53	± 0.48	195	± 1.51		
54.5	± 0.5	200	± 1.55	d 2	Tol
56	± 0.51	206	± 1.59	≤ 1.8	± 0.08
58	± 0.52	212	± 1.63	≤ 2.65	± 0.09
60	± 0.54	218	± 1.67	≤ 3.55	± 0.1
61.5	± 0.55	224	± 1.71	≤ 5.3	± 0.13
63	± 0.56	230	± 1.75	≤ 7	± 0.15
65	± 0.58	236	± 1.79	≤ 8	± 0.16
67	± 0.59	243	± 1.83	≤ 10	± 0.18
69	± 0.61	250	± 1.88		
71	± 0.63	258	± 1.93		
73	± 0.64	265	± 1.98		

For intermediate sizes, the next tolerance up is chosen.

The dimensional tolerances of the finished O-ring are achieved by using appropriately designed form tools and allowing for the shrinkage factor of the elastomer. It is often possible to use moulds and elastomers with similar shrinkage; in these cases the tolerances in the above chart do not apply.

The quoted tolerances can be reduced even further by modifying the elastomer and using special manufacturing procedures.

Quality assurance information (measuring aids, procedures)

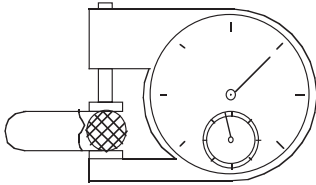
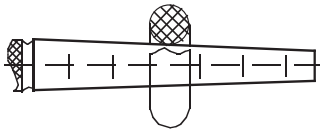

Ideally, the inner diameter ($\varnothing d_1$) is measured by using conical with step barrel gauges. The individual barrel gauges are designed to suit each particular measuring range. A circumferential measuring tape is sufficient for O-rings with an inner diameter of more than 250 mm. Non-contact optical measuring is advised for very small O-rings (less than 1 mm inner diameter).

The cross section of the O-ring ($\varnothing d_2$) is measured with a dial gauge. The contact force between the measuring surfaces should be 1 N.

Shape and surface deviations

Acting in close cooperation with customers and adapting production techniques, Dichtomatik works actively to achieve a product quality with zero faults. However, this is highly labour- and cost-intensive.

DIN 3771 is therefore an attempt to find a balance between economic production and acceptable types of error. Part 4 contains descriptions of these types of error and differentiates between permissible form and surface deviations according to type features N and S given in the following tabel. The size of the permissible error is the difference between the two types.

Dichtomatik's quality standards for O-rings are the same as those in DIN 3771-4 type feature N. The special quality according to type features S and other, more specific requirements can also be offered as the basis for the delivery.

Form and surface deviations

Types of deviation

Offset/mismatch

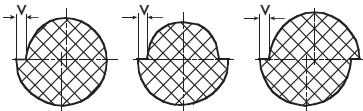

Flash offset and narting line projection

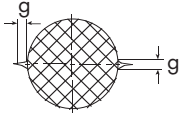

Backrind

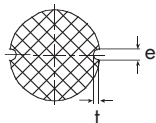

Excessive trimming

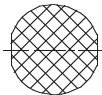

Flowmarks

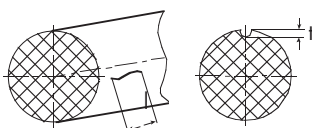

Non-fills and indentation

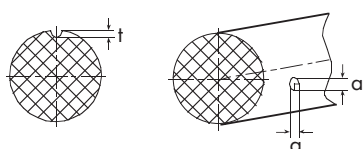

Type features N

Cross section (d_2)

Di. 1.8 2.65 3.55 5.3 7

v 0.08 0.1 0.13 0.15 0.15

g 0.1 0.12 0.14 0.16 0.18

e 0.18 0.27 0.36 0.53 0.7
t 0.08 0.08 0.1 0.1 0.13

Deviation from the circular cross section is permitted provided that the resultant

l 0.05 · d_1 or 1)
1.5 1.5 6.5 6.5 6.5
t 0.08
(radial orientation of flow marks is not permitted)

a 0.6 0.8 1 1.3 1.7
t 0.08 0.08 0.1 0.1 0.13

Type features S

Cross section (d_2)

1.8 2.65 3.55 5.3 7

0.08 0.08 0.1 0.12 0.13

0.1 0.1 0.13 0.15 0.15

0.1 0.15 0.2 0.2 0.3
0.08 0.08 0.1 0.1 0.13

surface is smoothly blended and is within the size tolerance limits for d_2 .

0.03 · d_1 or 1)
1.5 1.5 1 5 5
0.05

0.15 0.25 0.4 0.63 1
0.08 0.08 0.1 0.1 0.13

Materials

Dichtomatik offers O-rings in four standard and a wide range of special materials, most of which are elastomers. The starting material for elastomer is caoutchouc, which can be obtained in the form of natural rubber but is nowadays usually used in a synthetic form manufactured by the chemical industry.

Elastomers differ in the basic polymer from which they are made. The following table contains the nomenclature used for elastomers according to DIN ISO 1629 and ASTM D 1418.

Nomenclature for basic polymers

Chemical description	Abbreviation	
	DIN ISO 1629	ASTM D 1418
acrylonitrile-butadiene rubber	NBR	NBR
hydrogenated acrylonitrile-butadiene rubber	(HNBR)	HNBR
fluoro rubber	FPM	FKM
perfluoro rubber	(FFPM)	FFKM
ethylene propylene diene rubber	EPDM	EPDM
silicone rubber	VMQ	VMQ
fluorosilicone rubber	FVMQ	FVMQ
chloroprene rubber	CR	CR
polyester urethane	AU	AU
polyether urethane	EU	EU
natural rubber	NR	NR
acrylate rubber	ACM	ACM
styrene-butadiene rubber	SBR	SBR
ethylene oxide epichlorhydrine rubber	ECO	ECO
chlorosulfonated polyethylene	CSM	CSM
butadiene rubber	BR	BR
isoprene rubber	IR	IR
butyl rubber	IIR	IIR

() = not listed in the standard

The finished material is created by mixing the basic polymer with the appropriate fillers, softeners, processing aids, curing agents, accelerators and other additives. This process enables us to achieve the specified material properties and offer standard compounds for a wide range of applications as well as special mixtures for highly specialised applications.

The O-ring ultimately achieves its stable shape by the vulcanisation process, in which the plastic rubber mixture changes into a rubber-elastic state and the O-ring acquires its final mechanical properties (hardness, tensile strength, ultimate elongation, compression set etc.).



Standard elastomers

Dichtomatik has a wide range of O-ring sizes in four standard materials in stock:

Dichtomatik standard compounds

Basic elastomer	Abbreviation DIN ISO 1629	Hardness [Shore A]	Colour	Temp. range [°C]		
				low	high	
acrylonitrile-butadiene-rubber	NBR	70 80 + 90	black	-30 -25	100 100	120* 120*
fluororubber	FPM	80	black	-15	200	
ethylene propylene-diene rubber	EPDM	70	black	-45	130	
silicone rubber (methyl vinyl polysiloxane)	VMQ	70	red-brown	-55	200	

*short term

Temperature range and media resistance are primary criteria when choosing a material. Nevertheless, sufficient consideration must be given to the mechanical-technological values of an elastomer mixture as these are decisive for a seal's service life. Dichtomatik's resistance guide provides details of the different elastomer compounds' media resistance.

NBR – acrylonitrile-butadiene rubber / trade name e.g. Perbunan®- (Bayer)

NBR is the most common standard material for O-rings because of its good mechanical properties and resistance to mineral oil-based lubricants and greases. These properties are usually determined by the acrylonitrile content (ACN between 18% and 50%). A low ACN content ensures good flexibility at low temperatures, but offers limited resistance to oils and fuels; as the ACN content increases, the low temperature flexibility reduces and the resistance to oils and fuels improves.

The Dichtomatik standard NBR material for O-rings offers an average ACN content to suit a wide range of applications with balanced properties. It has good mechanical-technological values such as high abrasion resistance, as well as low gas permeability and good resistance to mineral oil-based lubricants and greases, hydraulic oils H, H-L, H-LP, non-flammable pressure liquids HFA, HFB, HFC, aliphatic hydrocarbons, silicone oil and greases, and water to approx. 80°C.

NBR is generally not resistant to aromatic and chlorinated hydrocarbons, fuels with a high aromatic content, polar solvents, glycol-based brake fluids and non-flammable hydraulic fluids HFD. It also has a low resistance to ozone, weathering and ageing, but in most applications this has no negative effect.



**FPM – fluoro rubber /
trade name e.g. Viton®
(Du Pont-Dow Elastomers)**

FPM materials are noted for their very high resistance to temperatures and chemicals. Other key benefits are its excellent resistance to ageing and ozone, very low gas permeability (excellent for vacuum application) and the fact that it is self-extinguishing.

The standard FPM material for O-rings has excellent resistance to mineral oils and greases, aliphatic, aromatic and chlorinated hydrocarbons, fuels, non-flammable hydraulic pressure fluids HFD and many organic solvents and chemicals.

In addition to the standard FPM materials, a number of special compounds with different compositions of polymer chains and varying fluoro-contents (65% to 71%) are developed for special applications.

FPM is generally not resistant to hot water, steam, polar solvents, glycol-based brake fluids and low-molecular organic acids.

**EPDM – ethylene propylene
diene rubber /
trade name e.g. Nordel®,
(Du Pont-Dow Elastomers)**

EPDM materials generally have a high resistance to hot water, steam, ageing and chemicals, and are suitable for a wide range of temperature applications. They are divided into sulphur- and peroxide-cured types. Peroxide-cured compounds are suitable for higher temperature ranges and have a much lower compression set.

EPDM has a good resistance to hot water and steam, detergents, caustic potash solutions, sodium hydroxide solutions, silicone oil and greases, many polar solvents, many diluted acids and chemicals. Special qualities are recommended for glycol-based brake fluids. EPDM materials are totally unsuitable for use with all mineral oil products (lubricants, fuels). They can be used between -45°C and $+130^{\circ}\text{C}$ (peroxide-cured -50°C to $+150^{\circ}\text{C}$).



**VMQ – silicone rubber /
trade name e.g. Silopren®
(Bayer)**

Silicone rubbers are noted for its wide thermal range and excellent resistance to ozone, weathering and ageing. Compared with other elastomers, silicone's mechanical properties are on the low side. Generally, silicone materials are physiologically harmless; they are also used by the food and medical industries.

The standard silicone material can be applied at temperatures from -55°C to $+200^{\circ}\text{C}$ and is resistant to water (up to 100°C), aliphatic engine and transmission oils, animal and plant oils and fats.

Silicone is generally not resistant to fuels, aromatic mineral oils, steam (short term up to 120°C possible), silicone oils and greases, acids and alkalis.

Comparison of several elastomer properties

Properties	Materials									
	NBR	FPM	EPDM sulphur	EPDM peroxide	VMQ	HNBR	FFPM	FVMQ	CR	AU / EU
Compression set	1	1	3	1	2	1	3	2	2	3
Tear strength	2	2	3	2	4	1	2	3	2	1
Abrasion resistance	2	2-3	2	2	4	2	3	3	2	1
Ageing resistance	4	1	2	2	1	2	1	1	2	1
Ozone resistance	4	1	2	2	1	2	1	1	2	1
Resistance to oil and grease	2	1	5	5	3	2	1	2	3	2
Fuel resistance	4**	2**	5	5	4	3	1	2	3	3
Resistance to hot water [°C]	80**	80**	130	150	100	100**	***	100	80	50
Resistance to steam [°C]	-	-	130	175	120*	-	***	120*	-	-
Heat resistance standard materials [°C]	100	200	130	150	200	150	260	175	100	100
Heat resistance special materials [°C]	120	-	-	-	250	-	330	-	-	-
Low temperature resistance standard materials [°C]	-30	-15	-45	-50	-55	-30	-15	-55	-40	-40
Low temperature resistance special materials [°C]	-50	-35	-	-	-	-40	-35	-	-50	-

1 = very good / 2 = good / 3 = average / 4 = low / 5 = weak

* =short term / ** = better result only with special compound /

*** = depends on compound



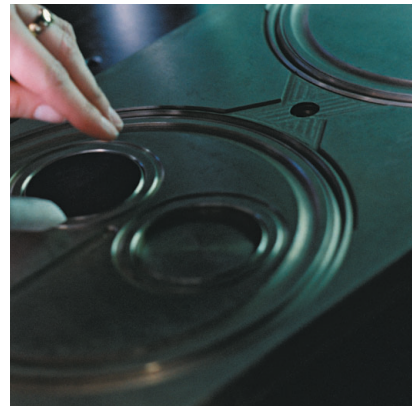

Special elastomers

HNBR – hydrogenated acrylonitrile-butadiene rubber / trade name e.g. Therban® (Bayer)

HNBR is obtained by fully or partly hydrogenating NBR. It leads to considerable improvement of the resistance to heat, ozone and ageing, and gives it very good mechanical properties. The media resistance compares to that of NBR.

FFPM – perfluoro rubber / trade name Kalrez® (Du Pont-DowElastomers)

The chemical and heat resistance of perfluoro elastomers are similar to those of PTFE. They combine the positive properties of PTFE with the elastic behaviour of FPM. Because this material group is considerably more expensive, perfluoro elastomers are only used if other materials cannot meet the specifications and if safety requirements justify the higher expenditure.

Typical applications for perfluoro elastomers include the chemical, oil and semi-conductor industries, high-vacuum technology, and the aerospace industry.

FVMQ – fluorosilicone rubber / trade name e.g. Silastic LS® (Dow Corning)

Although fluorosilicone elastomers have the same mechanical properties as silicone, they are far more resistant to oils and fuels. The temperature range of applications is somewhat more restricted than that of silicone.

CR – chloroprene rubber / trade name e.g. Neoprene® (Du Pont-Dow Elastomers)

Chloroprenes have excellent resistance to ozone, ageing and weathering and also good mechanical properties. They have average resistance to mineral oils, and are suitable for use with many refrigerants.

AU – polyester urethane EU – polyether urethane Polyurethane / trade name e.g. Desmopan® (Bayer)

Polyurethanes differ from classic elastomers in that they have much higher mechanical properties for example a high resistance to abrasion, wear and extrusion, a high tensile strength and tear resistance. The material is resistant to ageing and ozone, and can be used with mineral oils and greases, silicone oils and greases, non-inflammable fluids HFA and HFB and water up to of 50°C, as well as pure aliphatic hydrocarbons.

SBR – styrene-butadiene rubber / trade name e.g. Buna Hüls® (Hüls)

SBR is used in glycol-based brake fluids, water, alcohols, glycols, silicone oils and greases. The temperature application range is from -50°C to +100°C.



TFE/P – tetrafluoroethylene-propylene rubber / trade name e.g. Aflas® (3M)

TFE/P is a relatively new addition to the group of fluoroelastomers and is noted for its excellent thermal (0°C to +200°C) and chemical resistance. It is particularly suitable for use in hot water, steam, acids, alkaline solutions, ammonia, amines, alloyed engine and transmission oils, brake fluids (based on glycol, mineral oil and silicone oil), crude oil, sour gas.

ACM – acrylate rubber

ACM is used mainly by the automotive industry as it is resistant to engine, transmission and ATF oils even at high temperatures. The temperature application range is from -20°C to +150°C.

NR – natural rubber

Natural rubber is still obtained from the latex of certain plants. Vulcanised natural rubber has good low-temperature and mechanical properties and a high elasticity. NR vulcanised materials are resistant to water, glycols, alcohols, glycol-based brake fluids, silicone oils and greases and diluted acids and bases. The temperature application range is from approx. -50°C to +80°C.

PTFE O-rings, PTFE-encapsulated O-rings PTFE – polytetrafluoroethylene

PTFE is a fluorinated plastic material. It is noted for its almost universal resistance to chemicals, wide temperature range (-100°C to +250°C), extremely low coefficient of friction, physiological suitability and almost unlimited resistance to ozone, weathering and ageing.

Solid PTFE O-rings are far less elastic than elastomer O-rings, which means they are difficult to install (the installation space usually has to be split), and they tend to "flow", especially at high temperatures. This is why slotted PTFE O-rings and PTFE-encapsulated elastomer O-rings are used. The position of the gap (pure PTFE O-rings) or of the joint or overlap (PTFE-encapsulated O-rings) is determined here, depending on the particular application.

FEP-encapsulated O-rings FEP – fluorinated ethylene-propylene

FEP is a thermoplastic material with similar properties to PTFE. Seamless FEP-encapsulated O-rings have an elastic core in FPM or VMQ. They are used at very high thermal and chemical loads. The extremely high chemical resistance of the cover protects the elastic core material against the chosen medium. Another advantage of the cover is its very low coefficient of friction.

This results in a combination of very high chemical and thermal load-bearing ability and the elastic properties of standard commercial elastomers. The core material is chosen to suit the temperature range and medium.

Because of its limited flexibility, great care is required during installation. Warming the material in water or oil to between approx. 80°C and 100°C increases flexibility and supports the installation.

Depending on the core material, the temperature application range is from -55°C to +200°C.

Surface treatments, and antifriction

The typical properties of elastomer materials include the "good gripping" and "sticky" surface. The friction that occurs in certain applications and during the fitting of O-rings (particularly with automatic supply) may be a disadvantage. Friction can be reduced by different antifriction treatments as an aid to installation and to increase the service life. Possibilities include:

Short-term antifriction treatment, e.g. to aid installation, by surface treatment with:

- silicone oil
- graphite
- molybdenum disulfide (MoS_2)
- talcum powder.

Long-term antifriction treatment is achieved by

- halogenating (fluorinating)
- PTFE coating
- applying dry lubricants to the surface

Long-term friction reduction is achieved by incorporating a slide-intensifying additive in the elastomer mix, such as molybdenum disulphide (MoS_2) or PTFE.

Dichtomatik's application engineers are pleased to assist with choosing the suitable process.

"Labs-free" O-rings

"Labs-free" means that the O-rings are free from substances which interfere the lacquering process. The requirement "labs-free" includes "silicone-free" and goes beyond that. "Labs-free" O-rings are used primarily in automotive industry lacquering plants. Particles that disturb the lacquering process such as silicones, greases, wax etc. cause crater-shaped pitting on wet paint. Customer test requirements apply. Please contact us if you have a demand for "labs-free" O-rings.

Material approval

In addition to the usual requirements that apply for O-ring materials, special verification or approval may be required to confirm that a material is suitable for a specific application. Control and monitoring are very important if the seals are to be used in safety-technical, food or medical applications. Approval is required for use in the following applications:

- gas installation, gas equipment, gas supply
- drinking water fittings and supply
- food industry
- oxygen applications
- fire protection

Material approval is issued by recognised laboratories, authorised scientific-technical associations and state bodies. Sadly, most of the approvals are based on national rules, and even within Europe are rarely recognised by other member states. This means that even a material that is being used in similar or identical applications may need to be approved a number of times.

Summary of a number of material approvals:

Approval	Country	Application	Standard
DVGW Deutscher Verein des Gas und Wasserfaches e.V.	D	gas	DIN EN 549 (DIN 3535 T1+2) DIN 3535 T3
KTW (DVGW)	D	drinking water	KTW guidelines
BAM Bundesanstalt für Material- forschung und -prüfung	D	oxygen	BAM guidelines
BGA Bundesgesundheitsamt	D	food	BGA-guidelines
acc. to EN 681-1	EU	water supply and disposal	EN 681-1
WRC Water Research Council	GB	drinking water	BS 6920
FDA Food and Drug Administration	USA	food	Title 21 item 177.2600
NSF National Sanitary Foundation	USA	drinking water	Standard 61
UL Underwriter Laboratories	USA	fire protection	UL 94
KIWA	NL	drinking water	BRL 2013
ACS	F	drinking water	AFNOR XP 41-210/1/1/3

Dichtomatik carries O-rings made from materials with almost every current approval. Because of the variety and constantly changing number of approvals, we have decided against listing them individually, but do please ask for specific information. If we do not happen to have the approval that you require, we will immediately establish whether it is possible to apply for it.

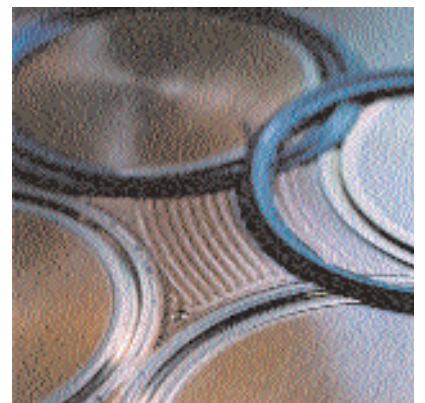

Terms from the materials data sheet

Elastomer materials are subject to strict quality controls throughout the manufacturing process. The appropriate tests are carried out on the caoutchouc or raw materials, and on the vulcanised rubber to monitor the manufacturing process. The characteristic properties of the vulcanised material are listed in the material data sheet.

The results given in the data sheet were obtained on standard test specimens following standard test procedures. Comparisons with results obtained on finished products, e.g. O-rings, will produce other results due to the different geometry, but these results will not necessarily contravene the contents of the data sheet. The following is an explanation of the main terms:

Hardness

The hardness of elastomer materials can be tested to Shore A or D (DIN 53505) or by indentation hardness to IRHD (DIN 53519 sheets 1 and 2). Shore A is the most frequently used test method, and IRHD micro hardness testing for smaller cross sections.

In both cases the hardness is the resistance of the elastomer test piece to the penetration of an indenter (a truncated cone for Shore A, and a sphere for micro IRHD) applied under a defined test load. The hardness is determined by the appropriate test equipment on standard test pieces and documented in data sheets. Because of the different geometry, the hardness test results obtained on a finished O-ring may differ from those of a standard test piece.

Tensile strength, ultimate elongation

The tensile test is described in DIN 53504. A standard test piece is stretched to rupture. The tensile strength is the maximum tensile stress in stretching a specimen to rupture.

The ultimate elongation is the elongation at which rupture occurs in the application of continued tensile stress.

Because of the different geometry of a finished O-ring compared with a test specimen, the values for tensile strength and breaking elongation on a finished O-ring may be less. This factor is to be taken into account when assessing the suitability of small O-rings for assembly over large diameters.

Tear resistance

Tear resistance is a measure of stress needed to continue rupturing a test specimen after a defined initiating cut. The tear resistance test is described for two different test pieces in DIN 53507 and DIN 53515. The value thereby obtained can be used to estimate an elastomer's sensitivity to further growth of damage in the case of a cut.



Low temperature

The mechanical properties of elastomers change as the temperature drops. Thus, for example, hardness and tear resistance increase whereas ultimate elongation reduces. From a particular temperature onwards, the material then becomes so hard and brittle that under load, it will crack like glass. If no mechanical load is applied to the frozen material (e.g. in storage), it will regain its original properties once warmed.

Various tests are available for assessing cold flexibility. Frequently used values are the brittleness point acc. to DIN 53546 and the TR10 temperature acc. to ASTM D 1329. These figures can be interpreted to draw conclusions regarding the practical low-temperature limit.

Compression set

Depending on the compound, time, temperature and initial deformation, elastomers show a certain "flow", a proportion of plastic deformation, in addition to their elastic behaviour. An item that has been installed in a housing for a certain period of time will not return completely to its original shape after removal, but will retain a certain amount of permanent deformation.

Compression set is tested to DIN 53517 or ASTM D 395 B, and will be somewhere between 0% and 100%; 0% is the ideal, and 100% the worst possible result. Compression set is calculated thus:

$$DVR = \frac{d_0 - d_2}{d_0 - d_1} \times 100$$

d_0 = the original thickness of the test specimen

d_1 = the thickness of the test specimen once deformed

d_2 = the thickness of the test specimen after relaxation

When assessing the value for the compression set it is important to observe the test parameters precisely. The same material can, for example, achieve better or worse results due to a change in temperature in the test. The same applies to the duration of the test.

Changes in properties after ageing

In order to assess the ageing behaviour and the materials' suitability for use in specific media, the changes in their properties are established after storage in these media.

DIN 53508 describes accelerated ageing in air. The determination of the resistance to liquids, vapours and gases is described in DIN 53521. The properties that are assessed are, for example, the absolute change in hardness and percentage change of tensile strength, ultimate elongation and volume in relation to the values of the unaged test specimen.

Storage of Elastomer products

Elastomers are generally easy to store. They retain almost exactly their original properties for several years, providing certain minimum storage criteria are observed. Those are described in standards DIN 7716 and ISO 2230.

It is important that seals are stored stress-free, without any tension, compression or deformation.

The elastomer seals should be protected from any intensive circulation of air. Storing the seals in the original packaging (e.g. polyethylene bags) or storing the seals in air-tight containers is recommended.

The storing room should be cool, dry, dust-free and ventilation should be moderate.

A constant storage temperature is recommended. It should not be lower than -10°C and not higher than $+20^{\circ}\text{C}$. Radiators in storage areas should be covered and kept a minimum of 1 m from the stored goods.

The relative humidity should not exceed 65%. Strong light influence, especially uv-radiation as well as direct sun light should be avoided.

Electrical equipment that creates ozone should not be placed in areas where elastomers are stored.



Installation housings and design recommendations

The installation housings

(grooves) for O-rings should if possible be produced with right angles. The dimensions for the required depth and width depend on the particular application and cross-section. The dimensions are recommendations for the particular type of installation, and refer to the nominal sizes. They should be observed because the sealing function depends on the precise execution of the grooves.

Static sealing

O-rings are ideal for sealing resting machine elements. We speak of a static or resting seal when the machine elements that are to be sealed do not move in relation to each other. If the groove is executed correctly, the items used as intended and the right material chosen, O-rings can seal pressures of up to 1000 bar. (Back-rings may also be required.)

Rectangular groove by radial deformation

This type of sealing is the preferred choice for sealing pins, bolts, tube connections or cylindrical tubes. The O-ring section is deformed radially on installation, i.e. in the direction of the centre of the bolt/pipe. The position of the groove, whether on the inside or the outside, does not play a functional part on solid components, but depends on the processing and installation possibilities. On thin walled parts where elastic deformation could occur such as with a cylindrical pipe, the groove should be on the fixed outer part (cylinder bottom) so that the groove on the side that is not subject to pressure does not increase as the item opens out.

Static sealing, internal sealing, rectangular groove by radial deformation

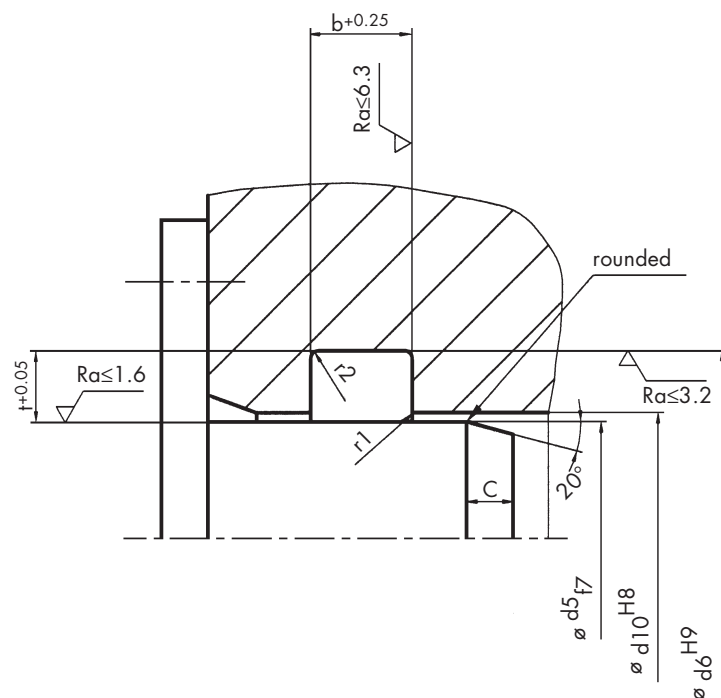
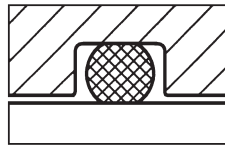

Groove dimensions

d2	Groove depth $t+0.05$	Groove width $b+0.25$	Lead-in chamfer C	d2	Groove depth $t+0.05$	Groove width $b+0.25$	Lead-in chamfer C
1	0.75	1.3	1.2	4	3.2	5.2	3
1.2	0.9	1.6	1.2	4.3	3.4	5.6	3
1.25	0.9	1.7	1.2	4.5	3.6	5.8	3
1.3	1	1.7	1.2	5	4	6.5	3
1.5	1.1	2	1.5	5.3	4.3	7	3
1.6	1.2	2.1	1.5	5.33	4.3	7.1	3.5
1.78	1.3	2.4	1.5	5.5	4.5	7.2	3.5
1.8	1.3	2.4	1.5	5.7	4.6	7.6	3.5
1.9	1.4	2.5	1.5	6	4.9	7.9	3.5
2	1.5	2.6	2	6.5	5.4	8.4	4
2.2	1.7	3	2	6.99	5.8	9.2	4
2.4	1.8	3.2	2	7	5.8	9.3	4
2.5	1.9	3.3	2	7.5	6.3	9.8	4
2.6	2	3.4	2	8	6.7	10.5	4
2.62	2	3.5	2	8.4	7.1	10.9	4.5
2.65	2	3.6	2	8.5	7.2	11	4.5
2.7	2.1	3.6	2	9	7.7	11.7	4.5
2.8	2.2	3.7	2	9.5	8.2	12.3	4.5
3	2.3	3.9	2.5	10	8.6	13	5
3.1	2.4	4	2.5	10.5	9	13.8	5
3.5	2.7	4.6	2.5	11	9.5	14.3	5
3.53	2.7	4.7	2.5	12	10.5	15.6	5
3.55	2.8	4.7	2.5	15	13.2	19.2	5
3.6	2.8	4.8	2.5				
3.7	2.9	4.9	2.5				

Static sealing, external sealing, rectangular groove by radial deformation

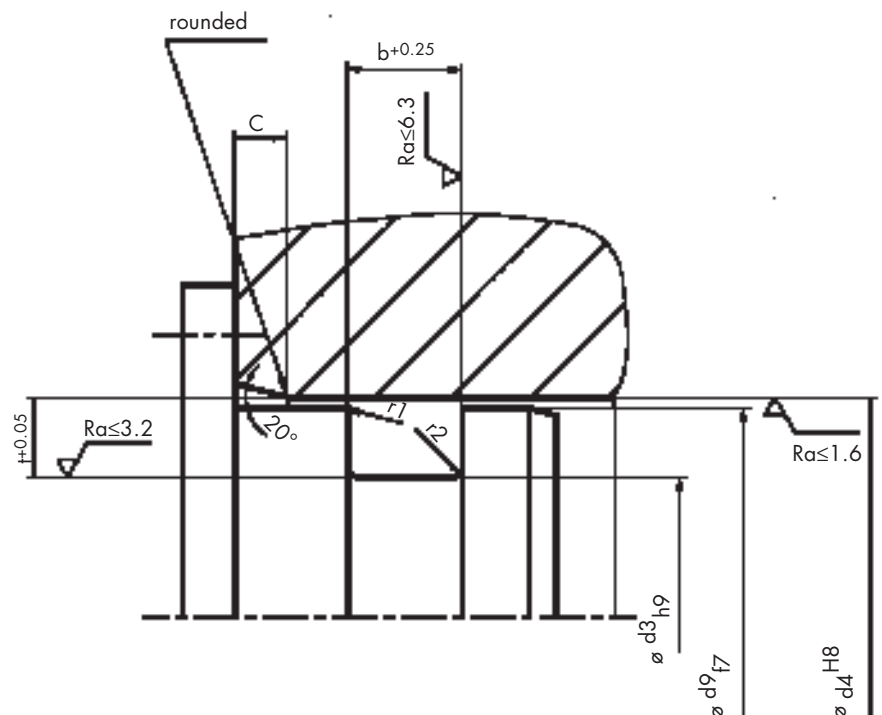

Rectangular groove by axial deformation

This type of installation is used primarily for flange and cover sealing. The O-ring cross section is deformed axially.

Note that the O-ring should be placed against the non-pressure side of the groove on installation in order to prevent it from moving in the groove when pressure is applied or increases.

If the O-ring moves in the groove, it will be stretched and compressed, which causes material fatigue and premature wear. Observing the pressure direction will prevent the surface of the O-ring from possibly rolling, and thus being destroyed.

■ If pressure is applied from the inside, the outer diameter of the O-ring should be placed against the outer diameter of the groove, or else be up to max. 3% bigger (the O-ring will be compressed).

■ If pressure is applied from the outside, the inner diameter of the O-ring should be placed against the inner diameter of the groove or else be up to max. 6% smaller (the O-ring will be stretched).

When the item is intended for axial installation, the cover screwing should be very strongly designed to ensure that the gap between the sealed surfaces never exceeds the permitted size. The pressure could otherwise squeeze out the O-ring.

Static sealing, pressure from inside, rectangular groove by axial deformation

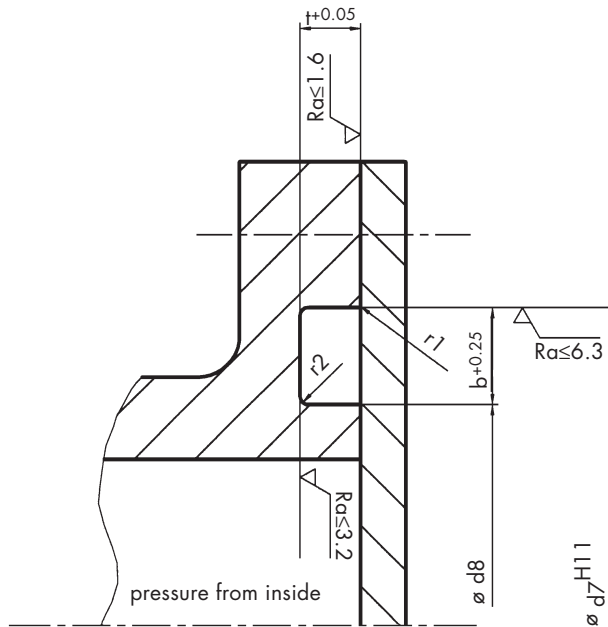
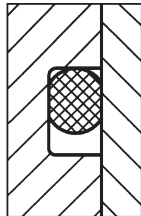

Groove dimensions

d2	Groove depth t+0.05	Groove width b+0.25	d2	Groove depth t+0.05	Groove width b+0.25
1	0.7	1.4	4	3.1	5.5
1.2	0.9	1.6	4.3	3.3	5.9
1.25	0.9	1.7	4.5	3.5	6.1
1.3	1	1.7	5	4	6.7
1.5	1.1	2.1	5.3	4.2	7.2
1.6	1.2	2.2	5.33	4.2	7.3
1.78	1.3	2.5	5.5	4.5	7.4
1.8	1.3	2.6	5.7	4.6	7.6
1.9	1.4	2.7	6	4.8	8.1
2	1.5	2.8	6.5	5.3	8.6
2.2	1.6	3.1	6.99	5.7	9.7
2.4	1.8	3.3	7	5.7	9.7
2.5	1.9	3.5	7.5	6.2	10.1
2.6	2	3.6	8	6.6	10.7
2.62	2	3.7	8.4	7.1	11.1
2.65	2	3.8	8.5	7.2	11.3
2.7	2.1	3.8	9	7.6	12
2.8	2.1	4	9.5	8.1	12.5
3	2.3	4.1	10	8.5	13.6
3.1	2.4	4.2	10.5	8.9	14
3.5	2.7	4.8	11	9.4	14.7
3.53	2.7	4.9	12	10.4	15.7
3.55	2.7	5	15	13.2	19.4
3.6	2.8	5.1			
3.7	2.9	5.2			

**Static sealing,
pressure from outside,
rectangular groove by
axial deformation**

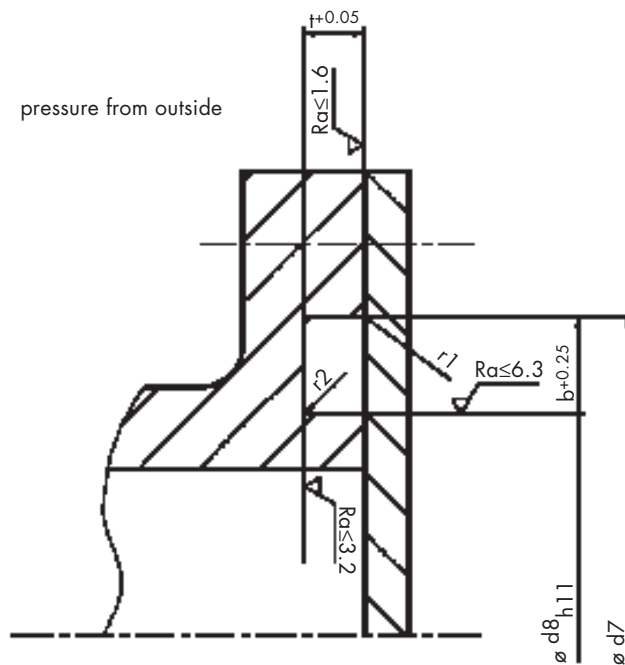

Trapezoidal groove

Trapezoidal grooves are difficult and expensive to manufacture. This groove geometry is only worthwhile if the O-ring needs to be held in the groove during assembly, for the application and removal of compression moulding tools, or for overhead installations.

A trapezoidal groove is really only advisable for cross sections of 2 mm and more. The average groove diameter equates to the inner diameter plus the cord thickness of the O-ring.

Static sealing, trapezoidal groove

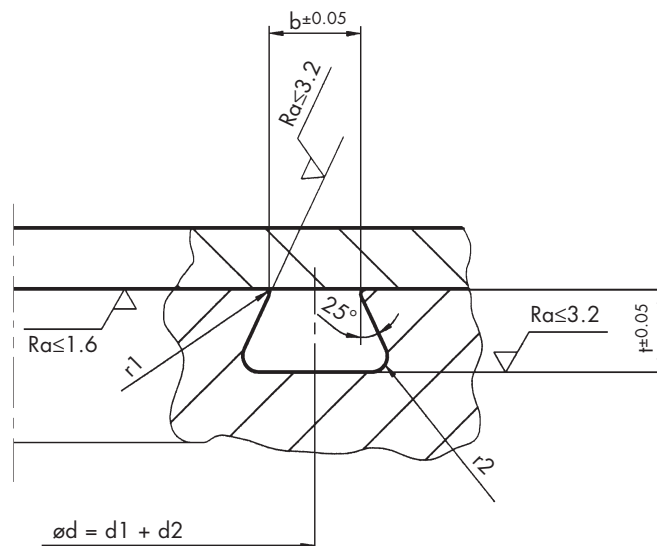
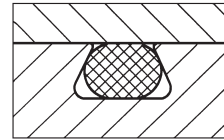
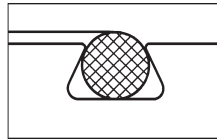

Groove dimensions

d2	Groove depth t\pm0.05	Groove width b\pm0.05	r2	r1
2	1.5	1.6	0.4	0.25
2.2	1.6	1.7	0.4	0.25
2.4	1.8	1.9	0.4	0.25
2.5	2	2	0.4	0.25
2.6	2.1	2.1	0.4	0.25
2.62	2.1	2.1	0.4	0.25
2.65	2.1	2.1	0.4	0.25
2.7	2.2	2.1	0.4	0.25
2.8	2.3	2.2	0.4	0.25
3	2.4	2.4	0.4	0.25
3.1	2.5	2.5	0.4	0.25
3.5	2.8	2.9	0.8	0.25
3.53	2.8	2.9	0.8	0.25
3.55	2.8	2.9	0.8	0.25
3.6	2.9	3	0.8	0.25
3.7	3	3.1	0.8	0.25
4	3.2	3.3	0.8	0.25
4.3	3.3	3.6	0.8	0.25
4.5	3.7	3.7	0.8	0.25
5	4.2	4	0.8	0.25
5.3	4.6	4.2	0.8	0.4
5.33	4.6	4.2	0.8	0.4
5.5	4.7	4.4	0.8	0.4
5.7	4.9	4.5	0.8	0.4
6	5.1	4.7	0.8	0.4
6.5	5.6	5.1	0.8	0.4
6.99	6	5.6	1.6	0.4
7	6	5.6	1.6	0.4
7.5	6.4	6.1	1.6	0.4
8	6.9	6.3	1.6	0.4
8.4	7.3	6.7	1.6	0.5
8.5	7.4	6.8	1.6	0.5
9	7.8	7.2	1.6	0.5
9.5	8.2	7.7	1.6	0.5
10	8.7	8	1.6	0.5

Conical groove

In individual cases involving screwed flange and cover sealing design, requirements may call for a conical groove. However, with this particular groove geometry it can be difficult to ensure a defined deformation of the O-ring. Furthermore, the restricted space of a conical groove can be disadvantageous if the surrounding media then cause the O-ring to swell.

Static sealing, conical groove

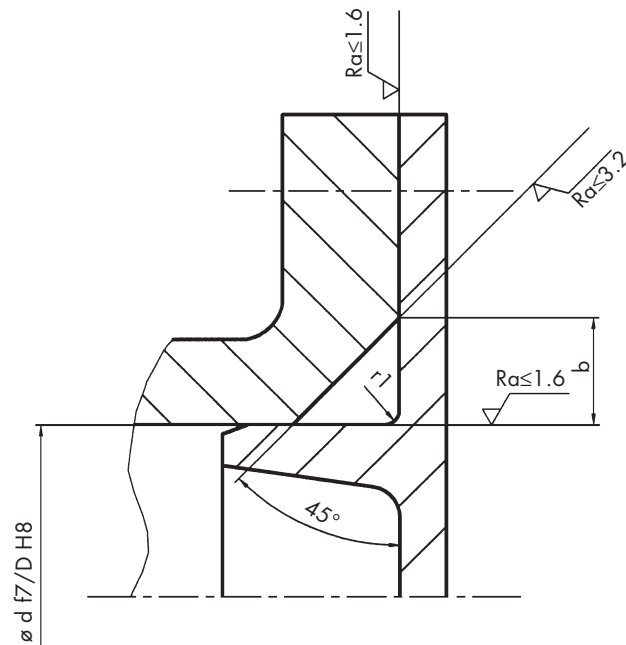
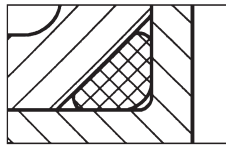

Groove dimensions	d2	Side length b	Tolerance (+) r1	
1	1.45		0.1	0.25
1.2	1.7		0.1	0.25
1.25	1.75		0.1	0.25
1.3	1.8		0.1	0.3
1.5	2.1		0.1	0.3
1.6	2.15		0.1	0.3
1.78	2.4		0.1	0.3
1.8	2.45		0.1	0.3
1.9	2.6		0.1	0.4
2	2.75		0.1	0.4
2.2	3		0.1	0.4
2.4	3.25		0.15	0.4
2.5	3.4		0.15	0.5
2.6	3.55		0.15	0.5
2.62	3.6		0.15	0.5
2.65	3.6		0.15	0.5
2.7	3.7		0.15	0.6
2.8	3.8		0.15	0.6
3	4.1		0.2	0.6
3.1	4.25		0.2	0.6
3.5	4.8		0.2	0.8
3.53	4.8		0.2	0.8
3.55	4.85		0.2	0.8
3.6	4.9		0.2	0.9
3.7	5.05		0.2	0.9
4	5.5		0.2	1.2
4.3	5.9		0.2	1.2
4.5	6.15		0.2	1.2
5	6.85		0.25	1.2
5.3	7.25		0.25	1.4
5.33	7.3		0.25	1.4
5.5	7.55		0.25	1.5
5.7	7.8		0.25	1.5
6	8.2		0.3	1.5
6.5	8.9		0.3	1.7
6.99	9.6		0.3	2
7	9.6		0.3	2
7.5	10.3		0.3	2
8	11		0.4	2
8.4	11.55		0.4	2
8.5	11.7		0.4	2
9	12.4		0.4	2.5
9.5	13.05		0.4	2.5
10	13.7		0.4	2.5
10.5	14.4		0.4	2.5
10	15.1		0.4	2.5
12	16.5		0.5	3
15	20.6		0.5	3

Vacuum sealing

Vacuum sealing is a special kind of static O-ring sealing. In this type, the system pressure that is to be sealed is less than the atmospheric pressure ($p_{\text{atm}} = 1.01325 \text{ bar}$).

Contrary to the general installation guidelines for static O-ring sealing, the following recommendations apply for vacuum sealing:

- The groove should be almost 100% filled by the deformed O-ring. This creates greater contact surfaces and increases the diffusion time through the elastomer material.

- The deformation of the O-ring section should be about 30%.

- A vacuum grease should be used (reduces leakage).

- The surface quality (roughness depth) of the groove and sealed surfaces should be considerably better than of standard static sealing, and the percentage contact area should be $t_p > 50\%$.

- The chosen elastomer should be gas compatible, have low permeability and a low compression set. We recommend fluoro rubber for standard applications.

Static sealing, vacuum sealing

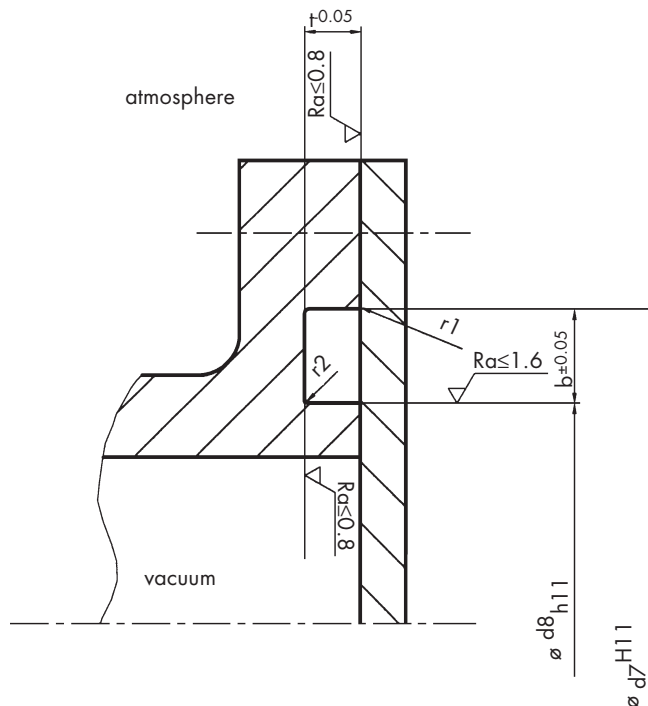
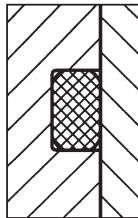

Groove dimensions

d2	Groove depth t_{-0.05}	Groove width b_{±0.05}	r1	r2
1.5	1.05	1.8	0.1	0.2
1.78	1.25	2.1	0.1	0.2
1.8	1.25	2.1	0.1	0.2
2	1.4	2.3	0.1	0.3
2.5	1.75	2.9	0.1	0.3
2.6	1.8	3	0.1	0.4
2.62	1.85	3.1	0.1	0.4
2.65	1.85	3.1	0.1	0.4
2.7	1.9	3.15	0.1	0.4
2.8	1.95	3.2	0.1	0.4
3	2.1	3.5	0.1	0.6
3.1	2.2	3.6	0.1	0.6
3.5	2.45	4.1	0.2	0.6
3.53	2.5	4.1	0.2	0.6
3.55	2.5	4.15	0.2	0.6
3.6	2.5	4.2	0.2	0.6
3.7	2.6	4.3	0.2	0.6
4	2.8	4.7	0.2	0.6
4.5	3.15	5.3	0.2	0.8
5	3.5	5.9	0.2	0.8
5.3	3.7	6.3	0.2	1
5.33	3.7	6.3	0.2	1
5.5	3.8	6.6	0.2	1
5.7	4	6.7	0.2	1
6	4.2	7.1	0.2	1
6.5	4.6	7.6	0.2	1
6.99	4.9	8.2	0.3	1
7	4.9	8.2	0.3	1
7.5	5.3	8.7	0.3	1
8	5.6	9.4	0.3	1
8.4	5.9	9.9	0.3	1
8.5	6	10	0.3	1
9	6.4	10.5	0.3	1
9.5	6.7	11.2	0.3	1
10	7.1	11.7	0.3	1

Dynamic sealing

O-rings are used successfully as sealing elements in dynamic applications. However, their use is limited to lower pressures and speeds, or to use in small installation housings.

Because of the friction resistance in movement, e.g. in hydraulic or pneumatic components, a smaller O-ring deformation is chosen than for static sealing. The item should always be well lubricated in order to prevent a loss of power due to friction and premature wear of the O-ring if it runs dry.

The installation housings are the same for the reciprocating movement, and for the movement with simultaneous rotating (helical) movement. There are differences between the housings of hydraulic and pneumatic applications, because of the differences in pressure and lubrication.

Hydraulics

O-rings should only be used to seal hydraulic pistons and rods if there is little space for the installation, or if the rod stroke is relatively short with a low frequency, and the seal does not have to be completely leak-proof. In fact, a tiny amount of leakage is desirable as it provides a lubricant film that reduces friction and wear.

**Dynamic sealing,
internal sealing,
rectangular groove by
radial deformation**

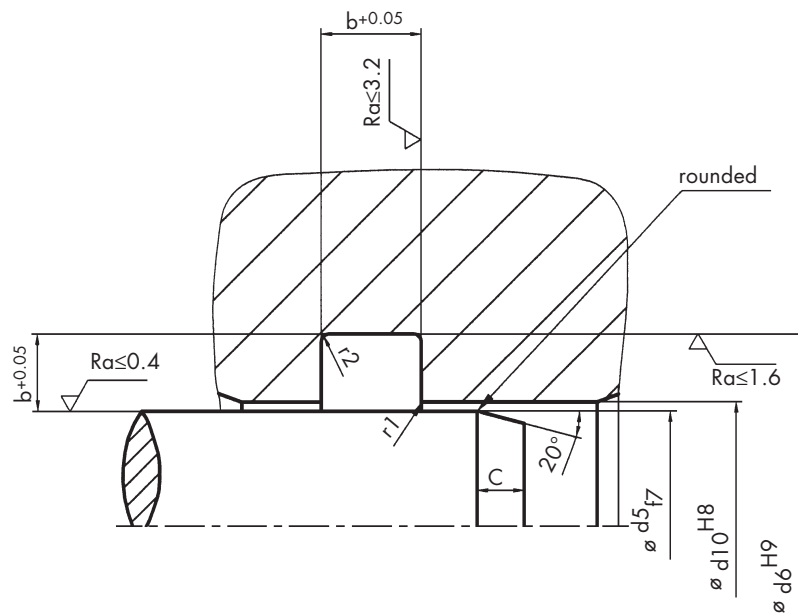
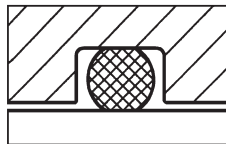

Groove dimensions

d2	Groove depth $t+0.05$	Groove width $b+0.25$	Lead-in chamfer C	d2	Groove depth $t+0.05$	Groove width $b+0.25$	Lead-in chamfer C
1	0.9	1.3	1	3.7	3.2	4.8	2
1.2	1	1.6	1	4	3.5	5.1	2
1.25	1.1	1.6	1	4.3	3.8	5.5	2.5
1.3	1.1	1.7	1.2	4.5	4	5.7	2.5
1.5	1.3	1.9	1.2	5	4.4	6.4	2.7
1.6	1.4	2	1.2	5.3	4.7	6.8	2.9
1.78	1.5	2.3	1.3	5.33	4.7	6.9	2.9
1.8	1.5	2.4	1.3	5.5	4.9	7.1	3
1.9	1.6	2.5	1.3	5.7	5.1	7.2	3
2	1.7	2.6	1.3	6	5.4	7.5	3.6
2.2	1.9	2.8	1.3	6.5	5.8	8.1	3.6
2.4	2.1	3	1.4	6.99	6.2	8.8	3.6
2.5	2.2	3.1	1.4	7	6.2	8.9	3.6
2.6	2.2	3.3	1.5	7.5	6.7	9.4	3.8
2.62	2.2	3.4	1.5	8	7.1	10.2	4
2.65	2.3	3.4	1.5	8.4	7.5	10.6	4.2
2.7	2.4	3.4	1.5	8.5	7.6	10.8	4.2
2.8	2.4	3.6	1.6	9	8.1	11.4	4.5
3	2.6	3.8	1.8	9.5	8.5	12	4.5
3.1	2.7	3.9	1.8	10	9	12.6	4.5
3.5	3.1	4.4	2	10.5	9.5	13.2	5
3.53	3.1	4.5	2	11	9.9	13.9	5
3.55	3.1	4.5	2	12	10.9	15.1	5
3.6	3.1	4.6	2	15	13.7	18.8	5

**Dynamic sealing,
external sealing,
rectangular groove by
radial deformation**

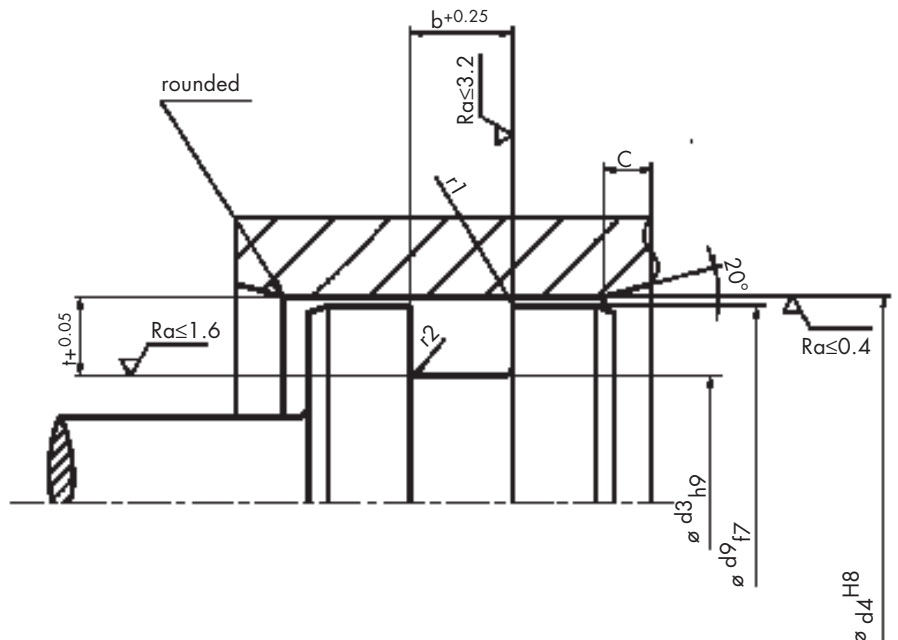

Pneumatics

In pneumatics, O-rings are used primarily to seal reciprocating movements. The deformation of the O-ring should be less than in hydraulic applications in order to keep the loss of power due to friction down, even with inadequate lubrication, in order to achieve the maximum possible lifetimes.

Dynamic sealing,
internal sealing,
rectangular groove by
radial deformation

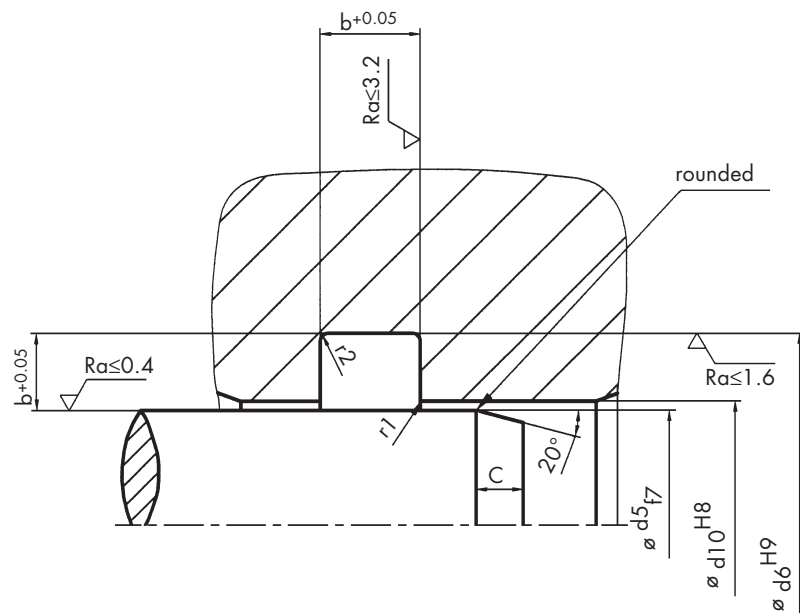
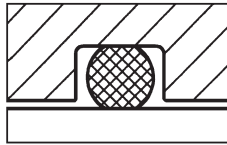

Groove dimensions

d2	Groove depth $t_{+0.05}$	Groove width $b_{+0.25}$	Lead-in chamfer C	d2	Groove depth $t_{+0.05}$	Groove width $b_{+0.25}$	Lead-in chamfer C
1	0.95	1.2	0.9	4	3.7	4.8	2
1.2	1.05	1.5	1	4.3	4	5.1	2
1.25	1.15	1.5	1	4.5	4.2	5.4	2.3
1.3	1.15	1.6	1.1	5	4.65	5.9	2.3
1.5	1.35	1.8	1.1	5.3	4.95	6.4	2.7
1.6	1.45	1.9	1.2	5.33	4.95	6.4	2.7
1.78	1.55	2.2	1.2	5.5	5.15	6.5	2.8
1.8	1.55	2.3	1.2	5.7	5.35	6.8	3
1.9	1.7	2.3	1.2	6	5.6	7.2	3.1
2	1.8	2.4	1.2	6.5	6.1	7.8	3.3
2.2	2	2.6	1.4	6.99	6.55	8.4	3.6
2.4	2.15	2.9	1.4	7	6.6	8.4	3.6
2.5	2.25	3	1.4	7.5	7.1	8.9	3.8
2.6	2.35	3.1	1.4	8	7.6	9.5	4
2.62	2.35	3.1	1.5	8.4	7.9	10.1	4.2
2.65	2.35	3.2	1.5	8.5	8	10.2	4.2
2.7	2.45	3.3	1.5	9	8.5	10.8	4.3
2.8	2.55	3.4	1.5	9.5	9	11.4	4.3
3	2.7	3.6	1.5	10	9.5	12	4.5
3.1	2.8	3.7	1.5				
3.5	3.15	4.2	1.8				
3.53	3.2	4.3	1.8				
3.55	3.2	4.3	1.8				
3.6	3.3	4.3	1.8				
3.7	3.4	4.4	1.8				

**Dynamic sealing,
external sealing,
rectangular groove by
radial deformation**

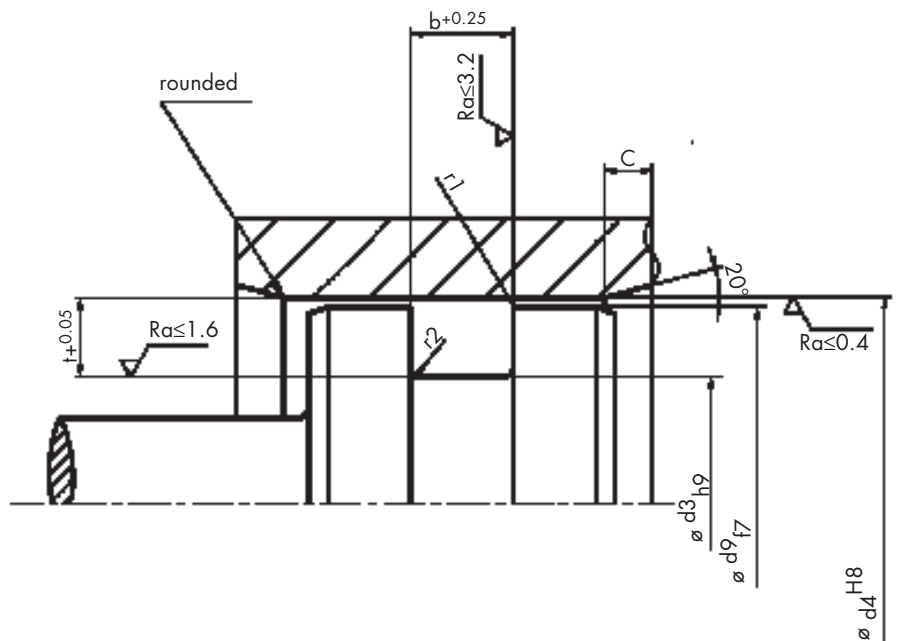

Design guidelines

Once the dimensions and geometric shape of the installation housing have been determined, the following details must be observed for a correct function.

■ Any component edges and transition points that come into contact with the O-ring should be burr-free, rounded and polished if necessary.

■ The transition point between the groove flank and groove base r_2 , and the transition between the groove flank and component surface r_1 , must be slightly rounded.

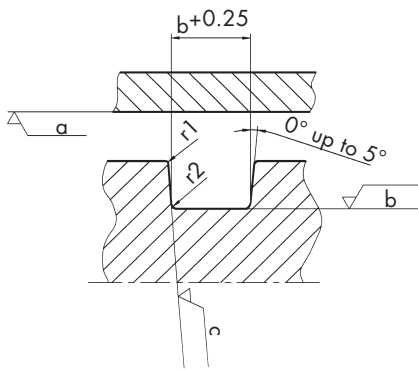

The radii relating to the cross section are given in the following table:

d2	r1	r2
1 – 2	0.1	0.3
2 – 3	0.2	0.3
3 – 4	0.2	0.5
4 – 5	0.2	0.6
5 – 6	0.2	0.6
6 – 8	0.2	0.8
8 – 10	0.2	1
10 – 12	0.2	1
12 – 15	0.2	1.2

■ The surface quality is to be designed for the particular application. For dynamic applications, the surface must be finer than for a static one; the same also applies for pulsating pressures.

Surface qualities

Type of sealing application	Surface	Pressure	R_a [μm]	R_z [μm]	R_{max} [μm]
dynamic radial	counter surface a		≤ 0.4	≤ 1.2	≤ 1.6
	groove base b		≤ 1.6	≤ 3.2	≤ 6.3
	groove flanks c		≤ 3.2	≤ 6.3	≤ 10
static radial / axial	sealing surface a	not	≤ 1.6	≤ 6.3	≤ 10
	groove base b	pulsating	≤ 3.2	≤ 10	≤ 12.5
	groove flanks c		≤ 6.3	≤ 12.5	≤ 16
	sealed surface a	pulsating	≤ 0.8	≤ 1.6	≤ 3.2
	groove base b		≤ 1.6	≤ 3.2	≤ 6.3
	groove flanks c		≤ 3.2	≤ 6.3	≤ 10

■ Avoid marks, holes and scratches on the surface.

■ Roughness values are classified to DIN 4768 with various parameters. In many cases, simply stating the average roughness value R_a is not sufficient for classifying the surface quality, and so the average roughness depth R_z , maximum roughness depth R_{max} and the contact area percentage t_p are also quoted. The contact area percentage should be more than 50% if at all possible.

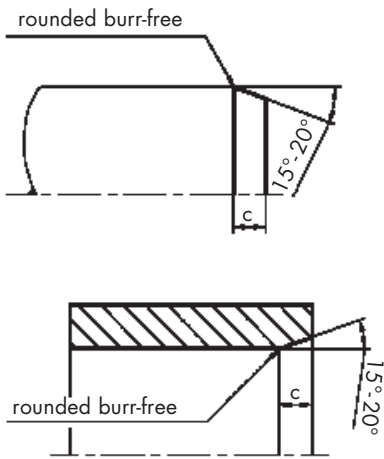

Lead-in chamfers

Lead-in chamfers should be used to prevent damage to the O-ring and ensure correct installation.

The angles between the lead-in chamfers and the level should be between 15° and 20°. Chamfer lengths C are given in the groove dimension tables.

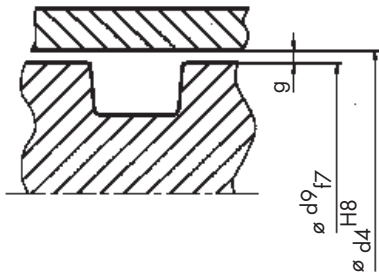

Maximum permitted values for radial sealing gap g [mm]

The permitted values for the sealing gap are determined by the pressure, material hardness and diameter.

Type of sealing application	Pressure [bar]	Material hardness [Shore A]		
		70	80	90
static	≤ 60	0.2	0.25	0.3
	> 60 – 100	0.1	0.2	0.25
	> 100 – 160	0.05	0.1	0.2
	> 160 – 250	–	0.05	0.1
	> 250 – 350	–	–	0.05
dynamic	≤ 30	0.2	0.25	0.3
	> 30 – 60	0.1	0.17	0.2
	> 60 – 80	–	0.1	0.15
	> 80 – 100	–	–	0.1

The gap dimensions given in the chart apply for all elastomer materials with the exception of silicone.

Sealing gap

The gap that is to be sealed should be as small as possible, so the fits and tolerances shown on installation tables and drawings should be observed.

However, do not forget that working loads, such as those exerted on a cylindrical tube under high pressure, will cause the gap to expand. If the gap is too big, there is a strong risk of gap extrusion. This means that the O-ring migrates into the gap as pressure is applied, where it will soon be destroyed.

In cases of dynamic sealing, the O-ring is destroyed by ripping and peeling. We recommend the use of back-up rings to protect the O-ring against gap extrusion.

Back-up rings are to be used with bigger gap dimensions.

Layout guidelines

In order to achieve the best possible sealing effect, the chosen O-rings should have the biggest possible cross section.

The hardness of the material destined for the O-ring depends on the pressures, gap widths (tolerances), type of sealing application (static, dynamic), and surface quality of the items being sealed. For standard applications we recommend a material hardness of 70 Shore A. For applications with, for example, pulsating pressures, and especially those under high pressure, we recommend materials of up to 90 Shore A.

Deformation

The sealing effect of the O-ring is provided by radial or axial deformation in the installation housing.

In a static application, the average deformation should be 15 – 30%, in relation to the cross section, in a dynamic (hydraulic) application 10 – 18%, and in a dynamic (pneumatic) application 4 – 12%

Stretching and compression

O-rings can be stretched or compressed to certain limits while being installed without this affecting the sealing function. The installed O-ring should not be stretched by more than 6% (in relation to the inside diameter) as this could lead to an unacceptably large reduction of the cross-sectional area, and also level off the inner sleeve. According to the rules of Galidinus, a 1% expansion of the inside diameter leads to a 0.5% reduction in cross section.

The compression of the O-ring should not exceed 3%, as otherwise the O-ring could distort in the groove.

Calculating the stretching and compression of the O-ring is easy with the following formula:

$$\text{Stretching} = \frac{(d3-d1)}{d1} \times 100\%$$

$$\text{Compression} = \frac{(da-d6)}{da} \times 100\%$$

$$da = (d1 + 2 \times d2)$$

d1 = O-ring inside diameter

d2 = O-ring cross section diameter

d3 = groove base diameter / inside

d6 = groove base diameter / outside

Groove filling

The rectangular cross section surface of the installation groove (except vacuum) should be about 25% bigger than the circular cross section of the O-ring. This means the O-ring has enough space for a possible increase in volume if it comes into contact with an aggressive medium. Also, the medium pressure may affect a large part of the O-ring surface in order to enhance the contact pressure required to achieve the sealing effect. The groove filling level should be 70% to 85%, and is easy to calculate with the following formula:

$$\text{Groove filling level} = \frac{A_{OR}}{A_{Nut}} \times 100\%$$

$$A_{OR} = d_2^2 \times \frac{\pi}{4}$$

$$A_{groove} = t \times b$$

General installation instructions

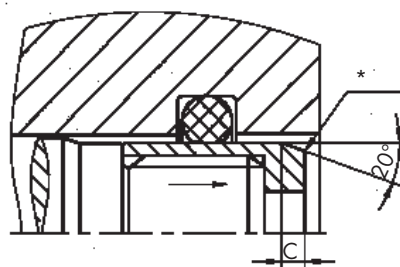
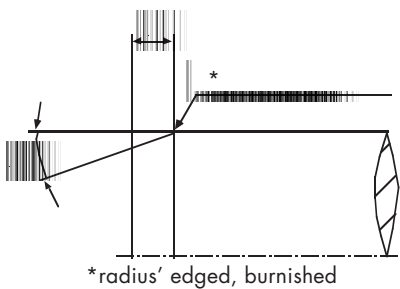
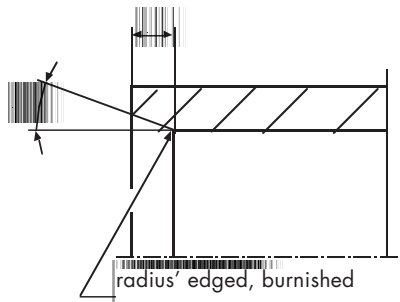

*radius' edged, burnished

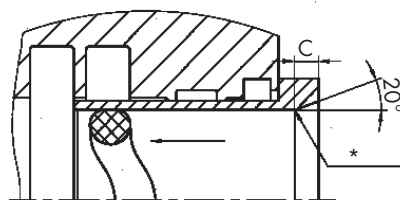

*radius' edged, burnished

Avoid damaging the O-ring during installation as this will cause leakage. Observe the following:

- The O-ring must not be expanded to its elongation limit.
 - Edges must be burr-free; radii and angles applied smoothly.
 - Dust, dirt, metal chips and other particles are to be removed.
-
- Tips of screws and installation housings for other sealing and guiding elements should be covered by an assembly sleeve.
 - A suitable grease is to be applied to the assembly surfaces and O-rings.
 - Elastomer materials are made smoother if they are heated in oil or hot water to approx. 80°C. This makes it easier to stretch the O-ring for assembly.
 - Any assembly tools used, such as expansion mandrels or sleeves, should be made of a soft material (e.g. POM) and not have any sharp edges.
 - The O-ring should not be rolled over assembly surfaces. Ensure the O-ring is not twisted as it slots into the groove.

Back-up rings

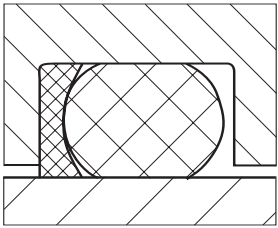
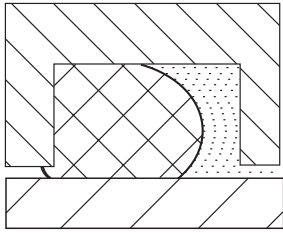

Back-up rings are used to prevent O-rings from gap extrusion. In the case of the combination of rising pressures and large sealing gaps there is the risk, that the O-ring material will be pressed into the sealing gap on the low pressure side. If this is repeated several times and the pressure continues rising, the O-ring can be damaged irreversible and finally get completely destroyed.

Back-up rings do not provide any sealing function. Through reduction of the sealing gap on the low pressure side they take care, that the O-ring can fulfill it's sealing function without being damaged.

Materials

The selection of materials for back-up rings is primarily based upon the pressure and the appropriate extrusion resistance resp. hardness. Additionally parameters like hight of the extrusion gap, media resistance and temperature range have to be taken into consideration. In practice there are various plastics and elastomers like for example PTFE, PA, POM, polyurethane, polyesterelastomer as well as NBR, FPM und EPDM available.

Installation housings

Back-up rings are normally installed in wider designed housings on the low pressure side. Because of the plurality of O-ring housings which are common in the market, the back-up ring dimensions normally have to be adapted to the existing housing geometry. To layout back-up rings the following parameters are required:

- housing dimensions,
including tolerances
- type of application:
static / dynamic sealing
internal / external sealing
- O-ring dimensions
pressure, medium, temperature

If back-up rings from existing dimension ranges are used e.g. like NBR 90 the installation housing has to be designed according to the producers guidelines.

Please contact us for any further assistance.

**Standard-
dimensions:**

**International
standard**

**Dichtomatik
dimensions**



Standard dimensions
British Standard BS 1806 /
American Standard AS 568 A

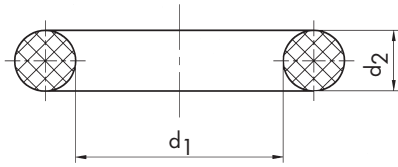

Ref.	d1	d2	Ref.	d1	d2	Ref.	d1	d2
1	0.74	1.02	111	10.78	2.62	167	177.47	2.62
2	1.07	1.27	112	12.37	2.62	168	183.83	2.62
3	1.42	1.52	113	13.95	2.62	169	190.18	2.62
4	1.78	1.78	114	15.54	2.62	170	196.53	2.62
5	2.57	1.78	115	17.13	2.62	171	202.87	2.62
6	2.9	1.78	116	18.72	2.62	172	209.23	2.62
7	3.68	1.78	117	20.29	2.62	173	215.58	2.62
8	4.48	1.78	118	21.89	2.62	174	221.932	32
9	5.28	1.78	119	23.47	2.62	175	228.28	2.62
10	6.07	1.78	120	25.07	2.62	176	234.63	2.62
11	7.66	1.78	121	26.64	2.62	177	240.98	2.62
12	9.25	1.78	122	28.25	2.62	178	247.33	2.62
13	10.82	1.78	123	29.82	2.62			
14	12.42	1.78	124	31.42	2.62			
15	14	1.78	125	33	2.62			
16	15.6	1.78	126	34.59	2.62	210	18.64	3.53
17	17.16	1.78	127	36.17	2.62	211	20.22	3.53
18	18.77	1.78	128	37.77	2.62	212	21.82	3.53
19	20.35	1.78	129	39.34	2.62	213	23.4	3.53
20	21.95	1.78	130	40.95	2.62	214	24.99	3.53
21	23.53	1.78	131	42.52	2.62	215	26.58	3.53
22	25.12	1.78	132	44.12	2.62	216	28.17	3.53
23	26.7	1.78	133	45.69	2.62	217	29.75	3.53
24	28.3	1.78	134	47.29	2.62	218	31.34	3.53
25	29.87	1.78	135	48.9	2.62	219	32.92	3.53
26	31.47	1.78	136	50.47	2.62	220	34.52	3.53
27	33.05	1.78	137	52.07	2.62	221	36.1	3.53
28	34.65	1.78	138	53.65	2.62	222	37.69	3.53
29	37.82	1.78	139	55.25	2.62	223	40.87	3.53
30	41	1.78	140	56.82	2.62	224	44.04	3.53
31	44.17	1.78	141	58.42	2.62	225	47.22	3.53
32	47.37	1.78	142	60	2.62	226	50.4	3.53
33	50.52	1.78	143	61.6	2.62	227	53.57	3.53
34	53.67	1.78	144	63.17	2.62	228	56.74	3.53
35	56.87	1.78	145	64.77	2.62	229	59.92	3.53
36	60.04	1.78	147	67.95	2.62	230	63.09	3.53
37	63.22	1.78	148	69.52	2.62	231	66.27	3.53
38	66.4	1.78	149	71.12	2.62	232	69.44	3.53
39	69.57	1.78	150	72.69	2.62	233	72.62	3.53
40	72.76	1.78	151	75.87	2.62	234	75.8	3.53
41	75.92	1.78	152	82.22	2.62	235	78.97	3.53
42	82.28	1.78	153	88.57	2.62	236	82.14	3.53
43	88.62	1.78	154	94.23	2.68	237	85.32	3.53
44	94.97	1.78	155	101.27	2.62	238	88.5	3.53
45	101.34	1.78	156	107.63	2.62	239	91.67	3.53
46	107.7	1.78	157	113.98	2.62	240	94.84	3.53
47	114	1.78	158	120.33	2.62	241	98.02	3.53
48	120.4	1.78	159	126.67	2.62	242	101.2	3.53
49	126.76	1.78	160	133	2.62	243	104.37	3.53
50	133.07	1.78	161	139.38	2.62	244	107.54	3.53
106	4.42	2.62	162	145.72	2.62	245	110.72	3.53
107	5.23	2.62	163	152.07	2.62	246	113.9	3.53
108	6.02	2.62	164	158.41	2.62	247	117.07	3.53
109	7.6	2.62	165	164.78	2.62	248	120.25	3.53
110	9.19	2.62	166	171.13	2.62	249	123.42	3.53

Ref.	d1	d2	Ref.	d1	d2	Ref.	d1	d2
250	126.6	3.53	345	100.97	5.33	429	126.37	6.99
251	129.77	3.53	346	104.14	5.33	430	129.54	6.99
252	132.94	3.53	347	107.32	5.33	431	132.72	6.99
253	136.12	3.53	348	110.49	5.33	432	135.9	6.99
254	139.3	3.53	349	113.67	5.33	433	139.07	6.99
255	142.47	3.53	350	116.84	5.33	434	142.24	6.99
256	145.65	3.53	351	120.02	5.33	435	145.42	6.99
257	148.82	3.53	352	123.2	5.33	436	148.6	6.99
258	151.99	3.53	353	126.37	5.33	437	151.77	6.99
259	158.35	3.53	354	129.54	5.33	438	158.12	6.99
260	164.7	3.53	355	132.72	5.33	439	164.47	6.99
261	171.05	3.53	356	135.9	5.33	440	170.82	6.99
261	177.4	3.53	357	139.07	5.33	441	177.17	6.99
263	183.75	3.53	358	142.24	5.33	442	183.52	6.99
264	190.1	3.53	359	145.42	5.33	443	189.87	6.99
265	196.44	3.53	360	148.6	5.33	444	196.22	6.99
266	202.79	3.53	361	151.77	5.33	445	202.57	6.99
267	209.14	3.53	362	158.12	5.33	445A*	208.92	6.99
268	215.49	3.53	363	164.47	5.33	446	215.27	6.99
269	221.84	3.53	364	170.82	5.33	446A*	221.62	6.99
270	228.19	3.53	365	177.17	5.33	447	227.97	6.99
271	234.54	3.53	366	183.52	5.33	447A*	234.32	6.99
272	240.89	3.53	367	189.87	5.33	448	240.67	6.99
273	247.24	3.53	368	196.22	5.33	448A*	247	6.99
274	253.59	3.53	369	202.57	5.33	449	253.57	6.99
275	266.3	3.53	370	208.92	5.33	449A*	259.7	6.99
276	279	3.53	371	215.27	5.33	450	266.07	6.99
277	291.7	3.53	372	221.62	5.33	450A*	272.40	6.99
278	304.39	3.53	373	227.97	5.33	451	278.77	6.99
279	329.8	3.53	374	234.32	5.33	451A*	285.1	6.99
280	355.2	3.53	375	240.67	5.33	452	291.47	6.99
281	380.6	3.53	376	247.02	5.33	452A*	297.8	6.99
282	405.26	3.53	377	253.37	5.33	453	304.17	6.99
283	430.66	3.53	378	266.07	5.33	454	316.87	6.99
284	456.06	3.53	379	278.77	5.33	455	329.57	6.99
325	37.47	5.33	380	291.47	5.33	456	342.27	6.99
326	40.65	5.33	381	304.17	5.33	457	354.97	6.99
327	43.82	5.33	382	329.57	5.33	458	367.67	6.99
328	47	5.33	383	354.97	5.33	459	380.37	6.99
329	50.16	5.33	384	380.37	5.33	460	393.07	6.99
330	53.34	5.33	385	405.26	5.33	461	405.26	6.99
331	56.52	5.33	386	430.66	5.33	462	417.96	6.99
332	59.7	5.33	387	456.06	5.33	463	430.66	6.99
233	62.87	5.33	388	481.46	5.33	464	443.36	6.99
334	66.04	5.33	389	506.81	5.33	465	456.06	6.99
335	69.22	5.33	390	532.2	5.33	466	468.76	6.99
336	72.4	5.33	391	557.6	5.33	467	481.46	6.99
337	75.57	5.33	392	582.68	5.33	468	494.16	6.99
338	78.74	5.33	393	608.08	5.33	469	506.86	6.99
339	81.92	5.33	394	633.48	5.33	470	532.26	6.99
340	85.09	5.33	395	658.88	5.33	471	557.66	6.99
341	88.27	5.33	425	113.67	6.99	472	582.68	6.99
342	91.44	5.33	426	116.84	6.99	473	608.08	6.99
343	94.62	5.33	427	120.02	6.99	474	633.48	6.99
344	97.8	5.33	428	123.2	6.99	475	658.88	6.99

* These dimensions are only listed in the BS 1806 standard.

**British Standard
metric BS 4518**

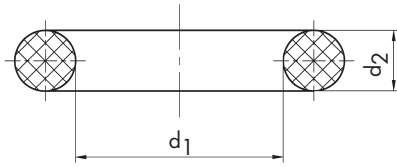

Ref.	d1	d2	Ref.	d1	d2	Ref.	d1	d2
0031-16	3.1	1.6	0476-24	47.6	2.4	1445-30	144.5	3
0041-16	4.1	1.6	0496-24	49.6	2.4	1495-30	149.5	3
0051-16	5.1	1.6	0516-24	51.6	2.4	1545-30	154.5	3
0061-16	6.1	1.6	0546-24	54.6	2.4	1595-30	159.5	3
0071-16	7.1	1.6	0556-24	55.6	2.4	1645-30	164.5	3
0081-16	8.1	1.6	0576-24	57.6	2.4	1695-30	169.5	3
0091-16	9.1	1.6	0586-24	58.6	2.4	1745-30	174.5	3
0101-16	10.1	1.6	0596-24	59.6	2.4	1795-30	179.5	3
0111-16	11.1	1.6	0616-24	61.6	2.4	1845-30	184.5	3
0121-16	12.1	1.6	0626-24	62.6	2.4	1895-30	189.5	3
0131-16	13.1	1.6	0646-24	64.6	2.4	1945-30	194.5	3
0141-16	14.1	1.6	0676-24	67.6	2.4	1995-30	199.5	3
0151-16	15.1	1.6	0696-24	69.6	2.4	2095-30	209.5	3
0161-16	16.1	1.6				2195-30	219.5	3
0171-16	17.1	1.6				2295-30	229.5	3
0181-16	18.1	1.6	0195-30	19.5	3	2395-30	239.5	3
0191-16	19.1	1.6	0215-30	21.5	3	2445-30	244.5	3
0221-16	22.1	1.6	0225-30	22.5	3	2495-30	249.5	3
0251-16	25.1	1.6	0245-30	24.5	3			
0271-16	27.1	1.6	0255-30	25.5	3			
0291-16	29.1	1.6	0265-30	26.5	3	0443-57	44.3	5.7
0321-16	32.1	1.6	0275-30	27.5	3	0453-57	45.3	5.7
0351-16	35.1	1.6	0295-30	29.5	3	0493-57	49.3	5.7
0371-16	37.1	1.6	0315-30	31.5	3	0523-57	52.3	5.7
			0325-30	32.5	3	0543-57	54.3	5.7
0036-24	3.6	2.4	0345-30	34.5	3	0553-57	55.3	5.7
0046-24	4.6	2.4	0355-30	35.5	3	0593-57	59.3	5.7
0056-24	5.6	2.4	0365-30	36.5	3	0623-57	62.3	5.7
0066-24	6.6	2.4	0375-30	37.5	3	0643-57	64.3	5.7
0076-24	7.6	2.4	0395-30	39.5	3	0693-57	69.3	5.7
0086-24	8.6	2.4	0415-30	41.5	3	0743-57	74.3	5.7
0096-24	9.6	2.4	0425-30	42.5	3	0793-57	79.3	5.7
0106-24	10.6	2.4	0445-30	44.5	3	0843-57	84.3	5.7
0116-24	11.6	2.4	0495-30	49.5	3	0893-57	89.3	5.7
0126-24	12.6	2.4	0545-30	54.5	3	0943-57	94.3	5.7
0136-24	13.6	2.4	0555-30	55.5	3	0993-57	99.3	5.7
0146-24	14.6	2.4	0575-30	57.5	3	1043-57	104.3	5.7
0156-24	15.6	2.4	0595-30	59.5	3	1093-57	109.3	5.7
0166-24	16.6	2.4	0625-30	62.5	3	1143-57	114.3	5.7
0176-24	17.6	2.4	0645-30	64.5	3	1193-57	119.3	5.7
0186-24	18.6	2.4	0695-30	69.5	3	1243-57	124.3	5.7
0196-24	19.6	2.4	0745-30	74.5	3	1293-57	129.3	5.7
0206-24	20.6	2.4	0795-30	79.5	3	1343-57	134.3	5.7
0216-24	21.6	2.4	0845-30	84.5	3	1393-57	139.3	5.7
0246-24	24.6	2.4	0895-30	89.5	3	1443-57	144.3	5.7
0276-24	27.6	2.4	0945-30	94.5	3	1493-57	149.3	5.7
0296-24	29.6	2.4	0995-30	99.5	3	1543-57	154.3	5.7
0316-24	31.6	2.4	1045-30	104.5	3	1593-57	159.3	5.7
0346-24	34.6	2.4	1095-30	109.5	3	1643-57	164.3	5.7
0356-24	35.6	2.4	1145-30	114.5	3	1693-57	169.3	5.7
0376-24	37.6	2.4	1195-30	119.5	3	1743-57	174.3	5.7
0396-24	39.6	2.4	1245-30	124.5	3	1793-57	179.3	5.7
0416-24	41.6	2.4	1295-30	129.5	3	1843-57	184.3	5.7
0446-24	44.6	2.4	1345-30	134.5	3	1893-57	189.3	5.7
0456-24	45.6	2.4	1395-30	139.5	3	1943-57	194.3	5.7

Ref.	d1	d2
------	----	----

1993-57	199.3	5.7
2093-57	209.3	5.7
2193-57	219.3	5.7
2293-57	229.3	5.7
2393-57	239.3	5.7

2493-57	249.3	5.7
2593-57	259.3	5.7
2693-57	269.3	5.7
2793-57	279.3	5.7
2893-57	289.3	5.7

2993-57	299.3	5.7
3093-57	309.3	5.7
3193-57	319.3	5.7
3393-57	339.3	5.7
3593-57	359.3	5.7

3793-57	379.3	5.7
3893-57	389.3	5.7
3993-57	399.3	5.7
4193-57	419.3	5.7
4393-57	439.3	5.7

4593-57	459.3	5.7
4793-57	479.3	5.7
4893-57	489.3	5.7
4993-57	499.3	5.7

1441-84	144.1	8.4
1491-84	149.1	8.4
1541-84	154.1	8.4
1591-84	159.1	8.4
1641-84	164.1	8.4

1691-84	169.1	8.4
1741-84	174.1	8.4
1791-84	179.1	8.4
1841-84	184.1	8.4
1891-84	189.1	8.4

1941-84	194.1	8.4
1991-84	199.1	8.4
2041-84	204.1	8.4
2091-84	209.1	8.4
2191-84	219.1	8.4

2291-84	229.1	8.4
2341-84	234.1	8.4
2391-84	239.1	8.4
2491-84	249.1	8.4

French Standard R

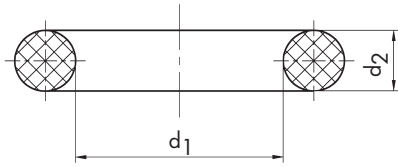

Ref.	d1	d2	Ref.	d1	d2
0	2.4	1.9	54	116.84	6.99
1	2.6	1.9	55	120.02	6.99
2	3.4	1.9	56	123.2	6.99
3	4.2	1.9	57	126.37	6.99
4	4.9	1.9	58	129.54	6.99
5	5.7	1.9	59	132.72	6.99
5a	6.4	1.9	60	135.9	6.99
6	7.2	1.9	61	139.07	6.99
6a	8	1.9	62	142.24	6.99
7	8.9	1.9	63	145.42	6.99
8	8.9	2.7	65	151.77	6.99
9	10.5	2.7	66	158.12	6.99
10	12.1	2.7	67	164.47	6.99
11	13.6	2.7	68	170.82	6.99
12	15.1	2.7	69	177.17	6.99
13	16.9	2.7	70	183.52	6.99
14	18.4	2.7	71	189.87	6.99
15	18.3	3.6	72	196.22	6.99
16	19.8	3.6	73	202.57	6.99
17	21.3	3.6	74	215.27	6.99
18	23	3.6	75	227.97	6.99
19	24.6	3.6	76	240.67	6.99
20	26.2	3.6	77	253.37	6.99
21	27.8	3.6	78	266.07	6.99
22	29.3	3.6	79	278.77	6.99
23	30.8	3.6	80	291.47	6.99
24	32.5	3.6	81	304.17	6.99
25	34.1	3.6	82	316.87	6.99
26	35.6	3.6	83	329.57	6.99
27	37.3	3.6	84	342.27	6.99
28	37.47	5.33	85	354.97	6.99
29	40.65	5.33	86	367.67	6.99
30	43.82	5.33	87	380.37	6.99
31	47	5.33	88	393.07	6.99
32	50.16	5.33			
33	53.34	5.33			
34	56.52	5.33			
36	62.87	5.33			
37	66.04	5.33			
38	69.22	5.33			
39	72.4	5.33			
40	75.57	5.33			
41	78.74	5.33			
42	81.92	5.33			
43	85.09	5.33			
44	88.27	5.33			
45	91.44	5.33			
46	94.62	5.33			
47	97.8	5.33			
48	100.97	5.33			
49	104.14	5.33			
50	107.32	5.33			
51	110.49	5.33			
52	113.67	5.33			
53	113.67	6.99			

Swedish Standard SMS 1586

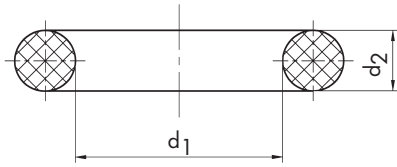

d1	d2	d1	d2	d1	d2
3.1	1.6	69.5	3	239.3	5.7
4.1	1.6	74.5	3	249.3	5.7
5.1	1.6	79.5	3	259.3	5.7
6.1	1.6	84.5	3	269.3	5.7
7.1	1.6	89.5	3	279.3	5.7
8.1	1.6	94.5	3	289.3	5.7
9.1	1.6	99.5	3	299.3	5.7
10.1	1.6	104.5	3	319.3	5.7
11.1	1.6	109.5	3	339.3	5.7
12.1	1.6	114.5	3	359.3	5.7
13.1	1.6	119.5	3	379.3	5.7
14.1	1.6	124.5	3	399.3	5.7
15.1	1.6	129.5	3	419.3	5.7
16.1	1.6	134.5	3	439.3	5.7
17.1	1.6	139.5	3	459.3	5.7
18.1	1.6	144.5	3	479.3	5.7
19.1	1.6			499.3	5.7
22.1	1.6				
25.1	1.6				
27.1	1.6				
29.1	1.6	44.2	5.7	144.1	8.4
32.1	1.6	49.2	5.7	149.1	8.4
35.1	1.6	54.2	5.7	154.1	8.4
37.1	1.6	59.2	5.7	159.1	8.4
		64.2	5.7	164.1	8.4
3.3	2.4	69.2	5.7	169.1	8.4
4.3	2.4	74.2	5.7	174.1	8.4
5.3	2.4	79.2	5.7	179.1	8.4
6.3	2.4	84.1	5.7	184.1	8.4
7.3	2.4	89.1	5.7	189.1	8.4
8.3	2.4	94.1	5.7	194.1	8.4
9.3	2.4	99.1	5.7	199.1	8.4
10.3	2.4	104.1	5.7	209.1	8.4
11.3	2.4	109.1	5.7	219.1	8.4
12.3	2.4	114.3	5.7	229.1	8.4
13.3	2.4	119.3	5.7	239.1	8.4
14.3	2.4	124.3	5.7	249.1	8.4
15.3	2.4	129.3	5.7		
16.3	2.4	134.3	5.7		
17.3	2.4	139.3	5.7		
19.2	3	144.3	5.7		
22.2	3	149.3	5.7		
24.2	3	154.3	5.7		
26.2	3	159.3	5.7		
29.2	3	164.3	5.7		
32.2	3	169.3	5.7		
34.2	3	174.3	5.7		
36.2	3	179.3	5.7		
39.2	3	184.3	5.7		
42.3	3	189.3	5.7		
44.2	3	194.3	5.7		
49.2	3	199.3	5.7		
54.2	3	209.3	5.7		
59.2	3	219.3	5.7		
64.5	3	229.3	5.7		

**Japanese Standard
JIS 240 P+G**

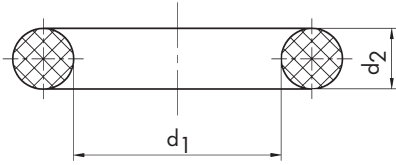

Ref.	d1	d2	Ref.	d1	d2	Ref.	d1	d2
P3	2.8	1.9	P22A	21.7	3.5	P48A	47.6	5.7
P4	3.8	1.9	P22.4	22.1	3.5	P50A	49.6	5.7
P5	4.8	1.9	P24	23.7	3.5	P52	51.6	5.7
P6	5.8	1.9	P25	24.7	3.5	P53	52.6	5.7
P7	6.8	1.9	P25.5	25.2	3.5	P55	54.6	5.7
P8	7.8	1.9	P26	25.7	3.5	P56	55.6	5.7
P9	8.8	1.9	P28	27.7	3.5	P58	57.6	5.7
P10	9.8	1.9	P29	28.7	3.5	P60	59.6	5.7
			P29.5	29.2	3.5	P62	61.6	5.7
			P30	29.7	3.5	P63	62.6	5.7
P10A	9.8	2.4	P31	30.7	3.5	P65	64.6	5.7
P11	10.8	2.4	P31.5	31.2	3.5	P67	66.6	5.7
P11.2	11	2.4	P32	31.7	3.5	P70	69.6	5.7
P12	11.8	2.4	P34	33.7	3.5	P71	70.6	5.7
P12.5	12.3	2.4	P35	34.7	3.5	P75	74.6	5.7
P14	13.8	2.4	P35.5	35.2	3.5	P80	79.6	5.7
P15	14.8	2.4	P36	35.7	3.5	P85	84.6	5.7
P16	15.8	2.4	P38	37.7	3.5	P90	89.6	5.7
P18	17.8	2.4	P39	38.7	3.5	P95	94.6	5.7
P20	19.8	2.4	P40	39.7	3.5	P100	99.6	5.7
P21	20.8	2.4	P41	40.7	3.5	P102	101.6	5.7
P22	21.8	2.4	P42	41.7	3.5	P105	104.6	5.7
			P44	43.7	3.5	P110	109.6	5.7
			P45	44.7	3.5	P112	111.6	5.7
			P46	45.7	3.5	P115	114.6	5.7
G25	24.4	3.1	P48	47.7	3.5	P120	119.6	5.7
G30	29.4	3.1	P49	48.7	3.5	P125	124.6	5.7
G35	34.4	3.1	P50	49.7	3.5	P130	129.6	5.7
G40	39.4	3.1				P132	131.6	5.7
G45	44.4	3.1				P135	134.6	5.7
G50	49.4	3.1				P140	139.6	5.7
G55	54.4	3.1				P145	144.6	5.7
G60	59.4	3.1				G150	149.3	5.7
G65	64.4	3.1				P150	149.6	5.7
G70	69.4	3.1				G155	154.3	5.7
G75	74.4	3.1				G160	159.3	5.7
G80	79.4	3.1				G165	164.3	5.7
G85	84.4	3.1				G170	169.3	5.7
G90	89.4	3.1				G175	174.3	5.7
G95	94.4	3.1				G180	179.3	5.7
G100	99.4	3.1				G185	184.3	5.7
G105	104.4	3.1				G190	189.3	5.7
G110	109.4	3.1				G195	194.3	5.7
G115	114.4	3.1				G200	199.3	5.7
G120	119.4	3.1				G210	209.3	5.7
G125	124.4	3.1				G220	219.3	5.7
G130	129.4	3.1				G230	229.3	5.7
G135	134.4	3.1				G240	239.3	5.7
G140	139.4	3.1				G250	249.3	5.7
G145	144.4	3.1				G260	259.3	5.7
						G270	269.3	5.7
						G280	279.3	5.7
						G290	289.3	5.7
						G300	299.3	5.7

Ref.	d1	d2
P150A	149.5	8.4
P155	154.5	8.4
P160	159.5	8.4
P165	164.5	8.4
P170	169.5	8.4
P175	174.5	8.4
P180	179.5	8.4
P185	184.5	8.4
P190	189.5	8.4
P195	194.5	8.4
P200	199.5	8.4
P205	204.5	8.4
P209	208.5	8.4
P210	209.5	8.4
P215	214.5	8.4
P220	219.5	8.4
P225	224.5	8.4
P230	229.5	8.4
P235	234.5	8.4
P240	239.5	8.4
P245	244.5	8.4
P250	249.5	8.4
P255	254.5	8.4
P260	259.5	8.4
P265	264.5	8.4
P270	269.5	8.4
P275	274.5	8.4
P280	279.5	8.4
P285	284.5	8.4
P290	289.5	8.4
P295	294.5	8.4
P300	299.5	8.4
P315	314.5	8.4
P320	319.5	8.4
P335	334.5	8.4
P340	339.5	8.4
P355	354.5	8.4
P360	359.5	8.4
P375	374.5	8.4
P385	384.5	8.4
P400	399.5	8.4

**Standard dimensions
DIN 3771**

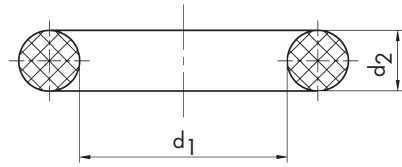

d1	d2	d1	d2	d1	d2	d1	d2
1.8	1.8	31.5	2.65	85	3.55	71	5.3
2	1.8	32.5	2.65	87.5	3.55	73	5.3
2.24	1.8	33.5	2.65	90	3.55	75	5.3
2.5	1.8	34.5	2.65	92.5	3.55	77.5	5.3
2.8	1.8	35.5	2.65	95	3.55	80	5.3
3.15	1.8	36.5	2.65	97.5	3.55	82.5	5.3
3.55	1.8	37.5	2.65	100	3.55	85	5.3
3.75	1.8	38.7	2.65	103	3.55	87.5	5.3
4	1.8			106	3.55	90	5.3
4.5	1.8			109	3.55	92.5	5.3
4.87	1.8	18	3.55	112	3.55	95	5.3
5	1.8	19	3.55	115	3.55	97.5	5.3
5.15	1.8	20	3.55	118	3.55	100	5.3
5.3	1.8	21.2	3.55	122	3.55	103	5.3
5.6	1.8	22.4	3.55	125	3.55	106	5.3
6	1.8	23.6	3.55	128	3.55	109	5.3
6.3	1.8	25	3.55	132	3.55	112	5.3
6.7	1.8	25.8	3.55	136	3.55	115	5.3
6.9	1.8	26.5	3.55	140	3.55	118	5.3
7.1	1.8	28	3.55	145	3.55	122	5.3
7.5	1.8	30	3.55	150	3.55	125	5.3
8	1.8	31.5	3.55	155	3.55	128	5.3
8.5	1.8	32.5	3.55	160	3.55	132	5.3
8.76	1.8	33.5	3.55	165	3.55	136	5.3
9	1.8	34.5	3.55	170	3.55	140	5.3
9.5	1.8	35.5	3.55	175	3.55	145	5.3
10	1.8	36.5	3.55	180	3.55	150	5.3
10.6	1.8	37.5	3.55	185	3.55	155	5.3
11.2	1.8	38.7	3.55	190	3.55	160	5.3
11.8	1.8	40	3.55	195	3.55	165	5.3
12.5	1.8	41.2	3.55	200	3.55	170	5.3
13.2	1.8	42.5	3.55			175	5.3
14	1.8	43.7	3.55			180	5.3
15	1.8	45	3.55			185	5.3
16	1.8	46.2	3.55			190	5.3
17	1.8	47.5	3.55	40	5.3	195	5.3
		48.7	3.55	41.2	5.3	200	5.3
		50	3.55	42.5	5.3	206	5.3
		51.5	3.55	43.7	5.3	212	5.3
		53	3.55	45	5.3	218	5.3
14	2.65	54.5	3.55	46.2	5.3	224	5.3
15	2.65	56	3.55	47.5	5.3	230	5.3
16	2.65	58	3.55	48.7	5.3	236	5.3
17	2.65	60	3.55	50	5.3	243	5.3
18	2.65	61.5	3.55	51.5	5.3	250	5.3
19	2.65	63	3.55	53	5.3	258	5.3
20	2.65	65	3.55	54.5	5.3	265	5.3
21.2	2.65	67	3.55	56	5.3	272	5.3
22.4	2.65	69	3.55	58	5.3	280	5.3
23.6	2.65	71	3.55	60	5.3	290	5.3
25	2.65	73	3.55	61.5	5.3	300	5.3
25.8	2.65	75	3.55	63	5.3	307	5.3
26.5	2.65	77.5	3.55	65	5.3	315	5.3
28	2.65	80	3.55	67	5.3	325	5.3
30	2.65	82.5	3.55	69	5.3	335	5.3

d1 d2

345 5.3
355 5.3
365 5.3
375 5.3
387 5.3

400 5.3

206 7
212 7
218 7
224 7
230 7

236 7
243 7
250 7
258 7
265 7

272 7
280 7
290 7
300 7
307 7

315 7
325 7
335 7
345 7
355 7

365 7
375 7
387 7
400 7
412 7

425 7
437 7
450 7
462 7
475 7

487 7
500 7
515 7
530 7
545 7

560 7
580 7
600 7
615 7
630 7

650 7
670 7

**Standard dimensions
ISO 3601-1 Series G**

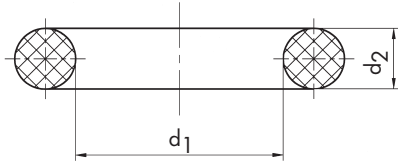

d1	d2	d1	d2	d1	d2	d1	d2
1.8	1.8	31.5	2.65	85	3.55	71	5.3
2	1.8	32.5	2.65	87.5	3.55	73	5.3
2.24	1.8	33.5	2.65	90	3.55	75	5.3
2.5	1.8	34.5	2.65	92.5	3.55	77.5	5.3
2.8	1.8	35.5	2.65	95	3.55	80	5.3
3.15	1.8	36.5	2.65	97.5	3.55	82.5	5.3
3.55	1.8	37.5	2.65	100	3.55	85	5.3
3.75	1.8	38.7	2.65	103	3.55	87.5	5.3
4	1.8			106	3.55	90	5.3
4.5	1.8			109	3.55	92.5	5.3
4.87	1.8	18	3.55	112	3.55	95	5.3
5	1.8	19	3.55	115	3.55	97.5	5.3
5.15	1.8	20	3.55	118	3.55	100	5.3
5.3	1.8	21.2	3.55	122	3.55	103	5.3
5.6	1.8	22.4	3.55	125	3.55	106	5.3
6	1.8	23.6	3.55	128	3.55	109	5.3
6.3	1.8	25	3.55	132	3.55	112	5.3
6.7	1.8	25.8	3.55	136	3.55	115	5.3
6.9	1.8	26.5	3.55	140	3.55	118	5.3
7.1	1.8	28	3.55	145	3.55	122	5.3
7.5	1.8	30	3.55	150	3.55	125	5.3
8	1.8	31.5	3.55	155	3.55	128	5.3
8.5	1.8	32.5	3.55	160	3.55	132	5.3
8.75	1.8	33.5	3.55	165	3.55	136	5.3
9	1.8	34.5	3.55	170	3.55	140	5.3
9.5	1.8	35.5	3.55	175	3.55	145	5.3
10	1.8	36.5	3.55	180	3.55	150	5.3
10.6	1.8	37.5	3.55	185	3.55	155	5.3
11.2	1.8	38.7	3.55	190	3.55	160	5.3
11.8	1.8	40	3.55	195	3.55	165	5.3
12.5	1.8	41.2	3.55	200	3.55	170	5.3
13.2	1.8	42.5	3.55			175	5.3
14	1.8	43.7	3.55			180	5.3
15	1.8	45	3.55			185	5.3
16	1.8	46.2	3.55			190	5.3
17	1.8	47.5	3.55	40	5.3	195	5.3
		48.7	3.55	41.2	5.3	200	5.3
		50	3.55	42.5	5.3	206	5.3
		51.5	3.55	43.7	5.3	212	5.3
		53	3.55	45	5.3	218	5.3
14	2.65	54.5	3.55	46.2	5.3	224	5.3
15	2.65	56	3.55	47.5	5.3	230	5.3
16	2.65	58	3.55	48.7	5.3	236	5.3
17	2.65	60	3.55	50	5.3	243	5.3
18	2.65	61.5	3.55	51.5	5.3	250	5.3
19	2.65	63	3.55	53	5.3	258	5.3
20	2.65	65	3.55	54.5	5.3	265	5.3
21.2	2.65	67	3.55	56	5.3	272	5.3
22.4	2.65	69	3.55	58	5.3	280	5.3
23.6	2.65	71	3.55	60	5.3	290	5.3
25	2.65	73	3.55	61.5	5.3	300	5.3
25.8	2.65	75	3.55	63	5.3	307	5.3
26.5	2.65	77.5	3.55	65	5.3	315	5.3
28	2.65	80	3.55	67	5.3	325	5.3
30	2.65	82.5	3.55	69	5.3	335	5.3

d1	d2	d1	d2
345	5.3	400	7
355	5.3	412	7
365	5.3	425	7
375	5.3	437	7
387	5.3	450	7
400	5.3	462	7
		475	7
		487	7
		500	7
		515	7
109	7	530	7
112	7	545	7
115	7	560	7
118	7	580	7
122	7	600	7
125	7	615	7
128	7	630	7
132	7	650	7
136	7	670	7
140	7		
145	7		
150	7		
155	7		
160	7		
165	7		
170	7		
175	7		
180	7		
185	7		
190	7		
195	7		
200	7		
206	7		
212	7		
218	7		
224	7		
230	7		
236	7		
243	7		
250	7		
258	7		
265	7		
272	7		
280	7		
290	7		
300	7		
307	7		
315	7		
325	7		
335	7		
345	7		
355	7		
365	7		
375	7		
387	7		

**Standard dimensions
ISO 3601-1 Series A**

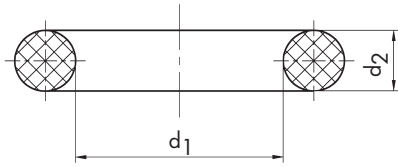

d_1	d_2	d_1	d_2	d_1	d_2	d_1	d_2
1.8	1.8	40	1.8	33.5	2.65	14	3.55
2	1.8	41.2	1.8	34.5	2.65	15	3.55
2.24	1.8	42.5	1.8	35.5	2.65	16	3.55
2.5	1.8	43.7	1.8	36.5	2.65	17	3.55
2.8	1.8	45	1.8	37.5	2.65	18	3.55
3.15	1.8	47.5	1.8	38.7	2.65	19	3.55
3.55	1.8	50	1.8	40	2.65	20	3.55
3.75	1.8	53	1.8	41.2	2.65	21.2	3.55
4	1.8	56	1.8	42.5	2.65	22.4	3.55
4.5	1.8	60	1.8	43.7	2.65	23.6	3.55
4.87	1.8	63	1.8	45	2.65	25	3.55
5	1.8	67	1.8	46.2	2.65	25.8	3.55
5.15	1.8	71	1.8	47.5	2.65	26.5	3.55
5.3	1.8	75	1.8	48.7	2.65	28	3.55
5.6	1.8	80	1.8	50	2.65	30	3.55
6	1.8	85	1.8	51.5	2.65	31.5	3.55
6.3	1.8	90	1.8	53	2.65	32.5	3.55
6.7	1.8	95	1.8	54.5	2.65	33.5	3.55
6.9	1.8	100	1.8	56	2.65	34.5	3.55
7.1	1.8	106	1.8	58	2.65	35.5	3.55
7.5	1.8	112	1.8	60	2.65	36.5	3.55
8	1.8	118	1.8	61.5	2.65	37.5	3.55
8.5	1.8	125	1.8	63	2.65	38.7	3.55
8.75	1.8			65	2.65	40	3.55
9	1.8			67	2.65	41.2	3.55
9.5	1.8	4.5	2.65	69	2.65	42.5	3.55
10	1.8	5.3	2.65	71	2.65	43.7	3.55
10.6	1.8	6	2.65	73	2.65	45	3.55
11.2	1.8	6.9	2.65	75	2.65	46.2	3.55
11.8	1.8	8	2.65	80	2.65	47.5	3.55
12.5	1.8	9	2.65	85	2.65	48.7	3.55
13.2	1.8	9.5	2.65	90	2.65	50	3.55
14	1.8	10	2.65	95	2.65	51.5	3.55
15	1.8	10.6	2.65	100	2.65	53	3.55
16	1.8	11.2	2.65	106	2.65	54.5	3.55
17	1.8	11.8	2.65	112	2.65	56	3.55
18	1.8	12.5	2.65	118	2.65	58	3.55
19	1.8	13.2	2.65	125	2.65	60	3.55
20	1.8	14	2.65	132	2.65	61.5	3.55
21.2	1.8	15	2.65	140	2.65	63	3.55
22.4	1.8	16	2.65	150	2.65	65	3.55
23.6	1.8	17	2.65	160	2.65	67	3.55
25	1.8	18	2.65	170	2.65	69	3.55
25.8	1.8	19	2.65	180	2.65	71	3.55
26.5	1.8	20	2.65	190	2.65	73	3.55
28	1.8	21.2	2.65	200	2.65	75	3.55
30	1.8	22.4	2.65	212	2.65	77.5	3.55
31.5	1.8	23.6	2.65	224	2.65	80	3.55
32.5	1.8	25	2.65	230	2.65	82.5	3.55
33.5	1.8	25.8	2.65	236	2.65	85	3.55
34.5	1.8	26.5	2.65	243	2.65	87.5	3.55
35.5	1.8	28	2.65	250	2.65	90	3.55
36.5	1.8	30	2.65			92.5	3.55
37.5	1.8	31.5	2.65			95	3.55
38.7	1.8	32.5	2.65			97.5	3.55

d1	d2	d1	d2	d1	d2
100	3.55	58	5.3	145	7
103	3.55	60	5.3	150	7
106	3.55	61.5	5.3	155	7
109	3.55	63	5.3	160	7
112	3.55	65	5.3	165	7
115	3.55	67	5.3	170	7
118	3.55	69	5.3	175	7
122	3.55	71	5.3	180	7
125	3.55	73	5.3	185	7
128	3.55	75	5.3	190	7
132	3.55	77.5	5.3	195	7
136	3.55	80	5.3	200	7
140	3.55	82.5	5.3	206	7
145	3.55	85	5.3	212	7
150	3.55	87.5	5.3	218	7
155	3.55	90	5.3	224	7
160	3.55	92.5	5.3	230	7
165	3.55	95	5.3	236	7
170	3.55	97.5	5.3	243	7
175	3.55	100	5.3	250	7
180	3.55	103	5.3	258	7
185	3.55	106	5.3	265	7
190	3.55	109	5.3	272	7
195	3.55	112	5.3	280	7
200	3.55	115	5.3	290	7
212	3.55	118	5.3	300	7
218	3.55	122	5.3	307	7
224	3.55	125	5.3	315	7
230	3.55	128	5.3	325	7
236	3.55	132	5.3	335	7
250	3.55	136	5.3	345	7
258	3.55	140	5.3	355	7
265	3.55	145	5.3	365	7
280	3.55	150	5.3	375	7
290	3.55	155	5.3	387	7
300	3.55	160	5.3	400	7
307	3.55	165	5.3		
315	3.55	170	5.3		
335	3.55	175	5.3		
355	3.55	180	5.3		
37.5	5.3	185	5.3		
38.7	5.3	190	5.3		
40	5.3	195	5.3		
41.2	5.3	200	5.3		
42.5	5.3				
43.7	5.3	109	7		
45	5.3	112	7		
46.2	5.3	115	7		
47.5	5.3	118	7		
48.7	5.3	122	7		
50	5.3	125	7		
51.5	5.3	128	7		
53	5.3	132	7		
54.5	5.3	136	7		
56	5.3	140	7		

Dichtomatik dimensions

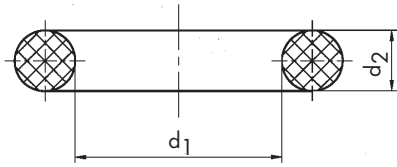

d1	d2	d1	d2	d1	d2	d1	d2
0.7	1.5	1.6	1.78	2.3	2.4	2.8	1.9
0.73	1.02	1.65	1.6	2.31	1.5	2.8	3.1
0.75	1	1.7	1.5	2.35	1	2.82	1.52
0.75	1.02	1.7	2.4	2.37	2.62	2.84	1.78
0.78	1.02	1.75	0.8	2.4	1.05	2.84	2.62
0.8	0.5	1.77	1.01	2.4	1.9	2.85	2.32
0.8	1.25	1.78	0.91	2.4	2.8	2.87	1.09
0.8	2	1.78	1.02	2.49	0.66	2.9	0.5
0.9	1.52	1.78	1.19	2.5	0.65	2.9	0.85
0.9	1.6	1.78	1.78	2.5	1	2.9	1
1	1	1.8	0.8	2.5	1.2	2.9	1.05
1	1.5	1.8	1	2.5	1.3	2.9	1.75
1	2	1.8	1.02	2.5	1.5	2.9	1.78
1.02	1.78	1.8	1.2	2.5	1.6	2.9	2.62
1.06	1.25	1.8	1.4	2.5	1.75	2.95	0.79
1.07	1.21	1.8	1.5	2.5	1.78	2.95	0.97
1.07	1.25	1.8	1.8	2.5	1.8	3	0.9
1.07	1.27	1.85	1.5	2.5	2	3	1
1.1	2	1.9	1.35	2.5	2.25	3	1.1
1.15	1	1.9	1.78	2.5	3	3	1.2
1.2	1	1.9	2.6	2.54	1.02	3	1.25
1.2	1.1	2	0.5	2.57	1.78	3	1.5
1.2	1.25	2	0.65	2.59	0.99	3	1.6
1.2	2	2	0.7	2.6	1	3	1.75
1.22	1.07	2	1	2.6	1.2	3	1.8
1.24	2.62	2	1.1	2.6	1.25	3	1.85
1.25	1	2	1.25	2.6	1.3	3	2
1.25	1.5	2	1.3	2.6	1.4	3	2.4
1.27	1.02	2	1.5	2.6	1.7	3	2.7
1.3	1	2	1.6	2.6	1.8	3	3
1.3	1.1	2	1.7	2.6	1.9	3	3.5
1.35	1.63	2	1.75	2.6	2	3	3.9
1.4	1.25	2	1.8	2.6	2.25	3	4
1.4	1.27	2	2	2.66	1.97	3	4.5
1.4	1.65	2	2.25	2.68	1.78	3.05	1.27
1.42	1.52	2	2.5	2.69	0.63	3.1	1.25
1.42	1.78	2	3	2.69	1.37	3.1	1.6
1.44	1.01	2.01	1.6	2.7	1	3.15	1.25
1.5	0.85	2.06	2.62	2.7	1.2	3.15	1.8
1.5	1	2.13	1.7	2.7	1.5	3.17	1.78
1.5	1.02	2.13	3.2	2.7	1.6	3.2	1
1.5	1.07	2.15	1.4	2.7	1.8	3.2	1.05
1.5	1.2	2.2	0.5	2.7	1.9	3.2	1.1
1.5	1.25	2.2	1	2.73	1.7	3.2	1.2
1.5	1.3	2.2	1.3	2.75	1.25	3.2	1.5
1.5	1.5	2.2	1.6	2.75	1.6	3.2	1.6
1.5	1.75	2.2	1.8	2.79	1.02	3.2	1.78
1.5	2	2.2	2.2	2.79	1.24	3.2	1.8
1.6	1	2.24	1.78	2.8	0.8	3.2	2.5
1.6	1.1	2.24	1.8	2.8	1	3.2	3
1.6	1.2	2.3	0.65	2.8	1.1	3.25	0.63
1.6	1.3	2.3	0.8	2.8	1.3	3.3	0.6
1.6	1.35	2.3	1.2	2.8	1.5	3.3	1
1.6	1.4	2.3	1.3	2.8	1.6	3.3	1.3
1.6	1.6	2.3	1.5	2.8	1.8	3.3	1.5

d1	d2	d1	d2	d1	d2	d1	d2	d1	d2	d1	d2
3.3	1.7	3.8	1.5	4.5	0.8	4.9	1.95	5.5	1.5	6	1.8
3.3	2.4	3.8	1.7	4.5	1	4.9	2.62	5.5	1.6	6	1.9
3.3	2.5	3.8	1.75	4.5	1.2	4.93	1.5	5.5	1.8	6	2
3.34	0.5	3.8	1.9	4.5	1.32	4.95	1.28	5.5	2	6	2.1
3.35	1.78	3.8	2.4	4.5	1.5	5	0.8	5.5	2.3	6	2.2
3.4	0.5	3.8	2.8	4.5	1.7	5	1	5.5	2.4	6	2.3
3.4	0.9	3.81	0.61	4.5	1.75	5	1.2	5.5	2.5	6	2.4
3.4	1	3.89	1.55	4.5	1.8	5	1.25	5.5	3	6	2.5
3.4	1.3	3.9	1.8	4.5	1.9	5	1.35	5.5	3.5	6	2.6
3.4	1.7	3.95	1.78	4.5	2	5	1.4	5.51	1.24	6	2.65
3.4	1.8	3.96	1.6	4.5	2.25	5	1.5	5.56	1.59	6	2.7
3.4	1.9	4	1	4.5	2.4	5	1.6	5.59	3.05	6	2.75
3.4	2.8	4	1.2	4.5	2.5	5	1.75	5.6	1	6	2.8
3.45	2.02	4	1.3	4.5	2.65	5	1.8	5.6	1.2	6	3
3.5	0.9	4	1.5	4.5	3	5	1.9	5.6	1.7	6	3.2
3.5	1	4	1.6	4.5	3.5	5	2	5.6	1.8	6	3.5
3.5	1.1	4	1.75	4.5	5	5	2.2	5.6	2	6	3.75
3.5	1.2	4	1.8	4.57	1.02	5	2.3	5.6	2.3	6	4
3.5	1.3	4	1.9	4.6	1.2	5	2.5	5.6	2.4	6	4.5
3.5	1.5	4	2	4.6	1.8	5	2.65	5.6	2.5	6	5
3.5	1.6	4	2.2	4.6	1.85	5	3	5.64	2.62	6	5.2
3.5	1.8	4	2.5	4.6	2	5	3.5	5.67	1.78	6	5.5
3.5	2	4	2.6	4.6	2.3	5	4	5.69	2.18	6	6
3.5	2.5	4	2.62	4.6	2.4	5	5	5.7	1	6	6.5
3.5	2.6	4	3	4.6	2.5	5	5.5	5.7	1.2	6	7
3.5	3	4	3.5	4.6	3.2	5	6	5.7	1.4	6.02	2.62
3.5	3.9	4	4	4.7	0.79	5	8	5.7	1.78	6.03	1.88
3.53	1.02	4	4.5	4.7	0.9	5.1	1	5.7	1.9	6.07	0.76
3.55	1.6	4	5	4.7	1	5.1	1.1	5.7	2.15	6.07	1.02
3.55	1.8	4	5.5	4.7	1.2	5.1	1.6	5.74	1.02	6.07	1.3
3.56	1.27	4.1	1.6	4.7	1.42	5.1	1.8	5.75	1	6.07	1.63
3.6	1.3	4.2	0.5	4.7	1.5	5.15	1.8	5.75	2.15	6.07	1.78
3.6	2	4.2	1.4	4.7	1.6	5.2	0.6	5.79	1.02	6.07	1.88
3.6	2.4	4.2	1.5	4.7	1.78	5.2	1.7	5.8	1.5	6.1	1.6
3.6	2.7	4.2	1.6	4.7	1.9	5.23	2.62	5.8	1.6	6.1	1.8
3.62	1.64	4.2	1.8	4.7	2.7	5.28	1.78	5.8	1.78	6.14	1.78
3.63	2.62	4.2	1.9	4.7	3	5.3	1.27	5.8	1.9	6.15	1
3.65	1.78	4.25	2	4.75	1	5.3	1.5	5.8	2.6	6.17	1.72
3.66	1.19	4.25	2.25	4.75	1.24	5.3	1.7	5.82	1.2	6.2	1
3.66	1.9	4.3	1	4.75	1.27	5.3	1.75	5.88	2.62	6.2	1.74
3.68	1.25	4.3	1.3	4.75	1.5	5.3	1.8	5.9	0.9	6.2	1.8
3.68	1.78	4.3	1.4	4.75	2.62	5.3	2	5.9	1.8	6.2	1.83
3.7	1	4.3	1.5	4.76	1.78	5.3	2.2	5.9	2.05	6.2	1.9
3.7	1.2	4.3	1.8	4.8	0.81	5.3	2.4	5.9	2.55	6.2	2
3.7	1.6	4.3	2.4	4.8	1.3	5.3	2.5	5.94	3.53	6.2	3
3.7	1.8	4.34	3.53	4.8	1.35	5.3	2.65	6	0.75	6.2	4.1
3.7	1.9	4.4	1.1	4.8	1.5	5.3	4.3	6	1	6.3	0.6
3.7	2.8	4.4	1.6	4.8	1.8	5.3	5	6	1.1	6.3	1.5
3.72	1.02	4.4	1.8	4.8	1.9	5.37	1.7	6	1.2	6.3	1.6
3.75	1.8	4.42	2.62	4.87	1.78	5.37	1.78	6	1.3	6.3	1.8
3.8	1	4.47	1.02	4.87	1.8	5.41	1.02	6	1.4	6.3	2
3.8	1.1	4.47	1.27	4.87	3.53	5.49	1.35	6	1.5	6.3	2.39
3.8	1.25	4.47	1.87	4.9	1.3	5.5	1	6	1.6	6.3	2.4
3.8	1.27	4.48	1.78	4.9	1.5	5.5	1.25	6	1.7	6.3	2.6
3.8	1.35	4.5	0.75	4.9	1.9	5.5	1.3	6	1.75	6.3	4.8

Dichtomatik dimensions

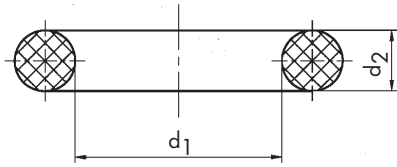

d1	d2	d1	d2	d1	d2	d1	d2
6.35	0.81	6.97	3.57	7.5	1.5	7.9	1.6
6.35	0.89	7	0.6	7.5	1.6	7.9	1.8
6.35	1	7	1	7.5	1.7	7.9	2.1
6.35	1.6	7	1.2	7.5	1.78	7.9	2.3
6.35	1.78	7	1.3	7.5	1.8	7.9	2.5
6.35	2.03	7	1.35	7.5	1.85	7.9	4.7
6.35	3.28	7	1.4	7.5	1.9	7.92	2.62
6.36	1.58	7	1.5	7.5	2	7.94	1.78
6.4	1.3	7	1.58	7.5	2.2	7.94	4.76
6.4	1.8	7	1.6	7.5	2.3	8	0.6
6.4	1.9	7	1.7	7.5	2.4	8	1
6.4	2.5	7	1.8	7.5	2.5	8	1.1
6.5	1	7	2	7.5	2.8	8	1.2
6.5	1.1	7	2.2	7.5	3	8	1.25
6.5	1.25	7	2.3	7.5	3.5	8	1.5
6.5	1.5	7	2.5	7.5	5	8	1.6
6.5	1.55	7	2.7	7.52	3.53	8	1.64
6.5	1.6	7	3	7.59	2.62	8	1.7
6.5	1.9	7	3.5	7.6	1.2	8	1.75
6.5	2	7	4	7.6	1.3	8	1.8
6.5	2.08	7	4.5	7.6	1.5	8	1.9
6.5	2.2	7	5	7.6	1.6	8	2
6.5	2.5	7	5.5	7.6	1.8	8	2.02
6.5	3	7	6	7.6	1.9	8	2.1
6.5	3.2	7	12	7.6	2	8	2.2
6.5	3.5	7.01	1.19	7.6	2.4	8	2.4
6.5	4	7.06	1.17	7.6	2.62	8	2.5
6.5	4.75	7.1	1.5	7.6	3	8	2.6
6.5	5	7.1	1.6	7.6	4	8	2.62
6.55	1	7.1	1.8	7.62	1.27	8	2.8
6.55	1.1	7.14	3.57	7.64	1.63	8	3
6.55	1.55	7.2	1	7.65	1.63	8	3.3
6.55	3.7	7.2	1.3	7.65	1.68	8	3.5
6.6	2.4	7.2	1.78	7.65	2.62	8	3.7
6.7	1.4	7.2	1.9	7.65	2.65	8	4
6.7	1.5	7.2	2.2	7.66	1.78	8	4.2
6.7	1.8	7.2	2.4	7.66	2.4	8	4.5
6.7	1.9	7.2	4.9	7.7	0.8	8	5
6.7	2	7.24	2.44	7.7	1.5	8	6
6.71	2.01	7.28	1.78	7.7	1.9	8	8
6.75	1.78	7.3	1.2	7.7	2	8.04	1
6.8	1.3	7.3	1.78	7.75	2.62	8.1	1.6
6.8	1.6	7.3	2.2	7.8	1.25	8.1	2.1
6.8	1.85	7.3	2.4	7.8	1.6	8.13	1.78
6.8	1.9	7.3	2.7	7.8	1.75	8.2	1.65
6.8	2	7.3	3.2	7.8	1.8	8.2	1.9
6.8	2.2	7.37	1.14	7.8	1.9	8.2	2
6.8	2.4	7.4	2	7.8	2	8.28	1.3
6.8	2.62	7.4	3	7.8	2.5	8.3	1
6.85	1.1	7.44	0.99	7.8	5	8.3	2.4
6.86	1.78	7.5	0.8	7.87	1.37	8.32	1.78
6.9	1.8	7.5	1	7.9	0.51	8.38	1.27
6.9	2.65	7.5	1.2	7.9	0.79	8.4	1.8
6.9	3.5	7.5	1.27	7.9	0.8	8.4	2.5
6.97	3.53	7.5	1.3	7.9	1.25	8.43	0.79

d1	d2	d1	d2	d1	d2	d1	d2	d1	d2	d1	d2
8.45	2.15	9	2.5	9.5	2.2	10	1.4	10.5	1.83	11	1.25
8.48	1.78	9	2.6	9.5	2.4	10	1.5	10.5	1.9	11	1.3
8.5	1	9	2.65	9.5	2.5	10	1.6	10.5	2	11	1.5
8.5	1.27	9	2.75	9.5	2.62	10	1.78	10.5	2.25	11	1.6
8.5	1.35	9	2.9	9.5	2.75	10	1.8	10.5	2.3	11	1.75
8.5	1.5	9	3	9.5	2.8	10	1.9	10.5	2.4	11	1.8
8.5	1.6	9	3.2	9.5	2.9	10	2	10.5	2.5	11	1.85
8.5	1.8	9	3.5	9.5	3	10	2.1	10.5	2.6	11	1.9
8.5	1.9	9	4	9.5	3.2	10	2.2	10.5	2.7	11	2
8.5	2	9	4.5	9.5	3.5	10	2.4	10.5	3	11	2.2
8.5	2.5	9	5	9.5	4.5	10	2.5	10.5	3.25	11	2.25
8.5	3	9	5.5	9.5	5	10	2.6	10.5	3.5	11	2.3
8.5	3.5	9	6	9.5	6	10	2.65	10.5	4.5	11	2.4
8.5	4	9	10	9.5	6.7	10	2.7	10.5	5.9	11	2.5
8.51	0.9	9.02	1.78	9.52	1.78	10	2.8	10.52	1.83	11	2.75
8.51	1.78	9.1	1.6	9.52	2.61	10	3	10.57	1.5	11	2.8
8.55	2.1	9.1	1.65	9.53	1.14	10	3.1	10.6	1	11	3
8.56	2.62	9.12	1.7	9.6	1.6	10	3.3	10.6	1.3	11	3.2
8.6	1.6	9.12	3.53	9.6	2	10	3.5	10.6	1.8	11	3.5
8.6	2.4	9.13	2.62	9.6	2.3	10	4	10.6	2	11	4
8.6	3	9.19	1.78	9.6	2.4	10	4.5	10.6	2.3	11	4.5
8.6	3.3	9.19	2.62	9.6	2.5	10	5	10.6	2.4	11	5
8.64	2.03	9.2	1	9.6	2.95	10	6	10.6	2.6	11	5.2
8.65	1.78	9.2	1.1	9.6	4.8	10	6.5	10.6	2.65	11	5.3
8.66	1.05	9.2	1.6	9.65	0.66	10	7	10.6	4.5	11	5.5
8.7	1.65	9.2	1.9	9.66	1.78	10	8	10.6	6.7	11	6
8.7	2	9.2	2	9.7	1	10	10	10.64	1.12	11	7
8.7	2.9	9.2	2.65	9.7	1.27	10.1	1	10.69	3.53	11	8
8.73	1.78	9.2	3.5	9.7	1.3	10.1	1.6	10.7	1.1	11.08	1.8
8.76	1.8	9.24	1.52	9.75	1.78	10.1	1.7	10.77	2.95	11.1	1.2
8.8	1.4	9.25	1.78	9.75	2.35	10.1	1.75	10.78	2.62	11.1	1.6
8.8	1.9	9.25	1.83	9.75	2.5	10.1	1.8	10.8	1.2	11.1	2.3
8.8	2.4	9.25	1.86	9.8	0.56	10.15	2.34	10.8	1.3	11.1	5.5
8.8	2.7	9.25	2.62	9.8	1	10.16	1.57	10.8	1.5	11.11	1.59
8.8	3.2	9.3	1.5	9.8	1.5	10.2	2.4	10.8	1.6	11.11	1.78
8.9	1.5	9.3	2	9.8	1.6	10.2	2.5	10.8	1.7	11.11	2.38
8.9	1.6	9.3	2.2	9.8	1.7	10.28	2.66	10.8	1.75	11.18	1.27
8.9	1.8	9.3	2.4	9.8	1.9	10.3	1.2	10.8	1.8	11.2	1.3
8.9	1.9	9.3	3	9.8	2.4	10.3	1.7	10.8	1.9	11.2	1.8
8.9	2.6	9.4	1	9.8	2.7	10.3	2.05	10.8	2	11.2	1.9
8.9	2.7	9.4	1.02	9.8	2.8	10.3	2.4	10.8	2.2	11.2	2.2
8.92	1.83	9.4	1.9	9.8	3	10.3	3	10.8	2.4	11.2	2.3
9	0.8	9.4	2.1	9.83	1.85	10.32	1.78	10.8	2.6	11.2	2.5
9	1	9.4	2.3	9.88	0.56	10.35	1.92	10.8	2.65	11.2	2.75
9	1.2	9.5	0.8	9.9	1.8	10.4	1	10.8	2.75	11.2	4.3
9	1.4	9.5	1	9.9	1.9	10.4	2.2	10.8	2.8	11.2	7.6
9	1.5	9.5	1.3	9.9	2.4	10.4	2.5	10.8	3	11.3	1.2
9	1.6	9.5	1.4	9.9	2.6	10.4	2.8	10.82	1.28	11.3	1.3
9	1.65	9.5	1.5	9.92	1.83	10.4	4	10.82	1.78	11.3	1.6
9	1.8	9.5	1.6	9.92	1.9	10.45	2	10.85	2.75	11.3	1.75
9	1.85	9.5	1.7	9.92	2.62	10.46	5.33	10.9	1.25	11.3	2
9	2	9.5	1.8	10	0.6	10.5	1	10.9	2.03	11.3	2.2
9	2.2	9.5	1.9	10	1	10.5	1.5	11	0.7	11.3	2.4
9	2.25	9.5	2	10	1.25	10.5	1.75	11	1	11.3	2.5
9	2.3	9.5	2.1	10	1.3	10.5	1.8	11	1.2	11.3	2.7

Dichtomatik dimensions

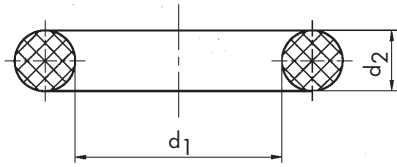

d1	d2	d1	d2	d1	d2	d1	d2
11.4	1.7	11.99	0.81	12.3	2.4	12.8	2.8
11.4	2.1	12	1	12.3	2.5	12.8	3.2
11.4	4.4	12	1.2	12.37	2.62	12.8	4.5
11.5	1	12	1.5	12.37	2.76	12.9	1.24
11.5	1.25	12	1.6	12.4	1	12.9	9.9
11.5	1.3	12	1.7	12.4	1.9	12.95	0.86
11.5	1.5	12	1.75	12.4	2	13	1
11.5	1.6	12	1.8	12.4	2.18	13	1.2
11.5	1.78	12	1.85	12.4	2.6	13	1.25
11.5	1.9	12	1.9	12.4	2.7	13	1.3
11.5	2	12	2	12.42	1.78	13	1.4
11.5	2.1	12	2.25	12.45	1.02	13	1.5
11.5	2.2	12	2.4	12.47	1.78	13	1.6
11.5	2.4	12	2.5	12.5	1	13	1.7
11.5	2.5	12	2.7	12.5	1.1	13	2
11.5	2.7	12	2.75	12.5	1.5	13	2.15
11.5	2.8	12	2.8	12.5	1.7	13	2.35
11.5	3	12	3	12.5	1.75	13	2.4
11.5	3.5	12	3.05	12.5	1.8	13	2.5
11.5	4	12	3.2	12.5	2	13	2.6
11.6	1.2	12	3.25	12.5	2.2	13	2.7
11.6	1.6	12	3.3	12.5	2.25	13	2.75
11.6	1.7	12	3.5	12.5	2.5	13	2.8
11.6	1.78	12	3.8	12.5	2.6	13	3
11.6	2.3	12	4	12.5	2.65	13	3.2
11.6	2.4	12	4.5	12.5	2.75	13	3.28
11.6	2.5	12	5	12.5	3	13	3.5
11.6	2.8	12	5.5	12.5	3.2	13	3.6
11.6	2.9	12	6	12.5	3.5	13	3.8
11.6	2.95	12	7	12.5	4.2	13	4
11.6	6.35	12	8	12.5	8	13	4.5
11.64	1.78	12	9	12.6	2.4	13	5
11.7	2.3	12	10	12.6	2.5	13	5.5
11.7	2.62	12.07	5.33	12.6	2.7	13	6
11.7	2.7	12.1	1.3	12.6	3.25	13	8
11.7	3.5	12.1	1.6	12.6	3.5	13.1	1.6
11.7	5.8	12.1	1.7	12.6	3.6	13.1	2.62
11.77	3.15	12.1	1.8	12.64	1.78	13.1	3.18
11.8	1.5	12.1	1.9	12.65	2.77	13.2	1.6
11.8	1.8	12.1	2.1	12.7	1.6	13.2	1.78
11.8	1.9	12.1	2.2	12.7	1.7	13.2	1.8
11.8	2.1	12.1	2.35	12.7	1.8	13.2	1.9
11.8	2.3	12.1	2.4	12.7	2	13.2	2.5
11.8	2.4	12.1	2.7	12.7	2.62	13.2	2.65
11.8	2.5	12.17	1.27	12.7	2.8	13.23	1.78
11.8	2.65	12.2	1.3	12.7	3.18	13.3	1.8
11.8	2.8	12.2	1.7	12.7	3.2	13.3	2.2
11.8	3	12.2	1.9	12.7	4.96	13.3	2.4
11.8	3.53	12.2	2.5	12.72	2.62	13.3	3.8
11.8	10	12.2	2.8	12.73	1.57	13.34	1.32
11.84	2.4	12.2	3.2	12.73	1.63	13.34	1.34
11.89	1.98	12.2	4.4	12.78	6.05	13.34	1.8
11.9	1.78	12.25	2.8	12.8	1.6	13.4	1.9
11.9	2.63	12.29	3.53	12.8	1.8	13.4	2.1
11.91	2.62	12.3	1	12.8	2.4	13.4	2.7

d1	d2	d1	d2	d1	d2	d1	d2	d1	d2	d1	d2
13.4	2.8	14	1.1	14.3	2.4	15	2.5	15.5	3	16	2.5
13.44	2.1	14	1.2	14.3	3.5	15	2.6	15.5	3.1	16	2.6
13.44	2.5	14	1.25	14.3	4	15	2.65	15.5	3.25	16	2.65
13.44	2.62	14	1.3	14.4	1	15	2.7	15.5	3.5	16	2.7
13.46	2.08	14	1.4	14.4	1.8	15	2.9	15.5	3.8	16	2.8
13.5	1	14	1.5	14.4	2	15	3	15.5	4	16	3
13.5	1.3	14	1.6	14.43	1.78	15	3.2	15.5	4.2	16	3.15
13.5	1.5	14	1.78	14.5	1	15	3.5	15.5	4.3	16	3.5
13.5	1.6	14	1.8	14.5	1.5	15	3.55	15.5	4.5	16	3.55
13.5	1.87	14	1.9	14.5	1.6	15	3.8	15.5	5.3	16	4
13.5	2	14	2	14.5	1.65	15	4	15.54	2.62	16	4.25
13.5	2.1	14	2.08	14.5	1.8	15	4.25	15.54	2.82	16	4.5
13.5	2.4	14	2.1	14.5	2	15	4.5	15.55	2.65	16	4.75
13.5	2.5	14	2.2	14.5	2.4	15	5	15.6	1.78	16	5
13.5	2.6	14	2.3	14.5	2.5	15	5.5	15.6	1.96	16	5.5
13.5	2.7	14	2.4	14.5	3	15	5.6	15.6	2	16	5.6
13.5	2.75	14	2.5	14.5	3.5	15	6	15.6	2.3	16	6
13.5	3	14	2.6	14.5	4	15	7	15.6	2.4	16	7
13.5	3.5	14	2.65	14.5	4.5	15	8	15.6	2.5	16	8
13.5	4.25	14	2.7	14.5	5	15	9	15.6	2.6	16	10
13.5	5	14	2.75	14.5	5.7	15	10	15.6	2.95	16	12
13.54	3.6	14	2.8	14.5	5.8	15	12.5	15.6	3	16.03	1.57
13.6	1.6	14	2.9	14.6	2.4	15.08	1.78	15.6	3.25	16.1	1.6
13.6	2	14	3	14.6	2.48	15.08	2.62	15.6	3.4	16.1	1.8
13.6	2.2	14	3.15	14.6	2.6	15.1	1.6	15.7	1.3	16.1	2.25
13.6	2.3	14	3.2	14.6	2.95	15.1	2.6	15.7	2.7	16.1	2.3
13.6	2.4	14	3.5	14.6	3.2	15.1	2.7	15.7	2.9	16.1	2.62
13.6	2.5	14	3.55	14.61	2.52	15.2	1.78	15.8	1.8	16.1	3
13.6	2.7	14	3.9	14.61	3.28	15.2	1.8	15.8	2.4	16.1	3.5
13.6	2.75	14	4	14.63	3.53	15.2	2.8	15.8	4.1	16.2	1.15
13.6	2.8	14	4.5	14.65	2	15.2	4	15.85	2.4	16.2	2.25
13.6	3	14	5	14.68	1.02	15.22	2.62	15.88	1.78	16.3	2.4
13.6	3.6	14	5.3	14.7	1.4	15.24	1.33	15.88	2.36	16.3	2.5
13.64	5.33	14	6	14.7	1.57	15.24	5.33	15.88	2.62	16.3	2.6
13.65	2.62	14	6.5	14.8	1.5	15.3	1.78	15.88	3.96	16.33	0.79
13.7	2.9	14	7	14.8	2.4	15.3	2	15.9	2.3	16.36	2.2
13.7	4.15	14	7.5	14.81	1.02	15.3	2.3	15.9	2.4	16.36	2.21
13.8	1.9	14	8	14.82	1.78	15.3	2.4	15.9	2.55	16.4	1.3
13.8	2	14	10	14.85	1.5	15.3	4.3	15.9	2.7	16.4	1.78
13.8	2.4	14.01	2.62	14.87	3.53	15.39	0.76	16	0.9	16.4	2.2
13.8	2.54	14.1	1	14.9	2.45	15.4	1	16	1	16.5	1
13.8	3	14.1	1.6	14.94	2.92	15.4	1.5	16	1.2	16.5	1.5
13.8	6	14.1	2.2	15	1	15.4	2.1	16	1.25	16.5	2
13.85	1.52	14.1	2.5	15	1.2	15.4	3	16	1.5	16.5	2.25
13.87	1.7	14.12	2.62	15	1.25	15.47	3.53	16	1.6	16.5	2.5
13.87	3.53	14.2	1.2	15	1.3	15.5	1	16	1.7	16.5	3
13.9	2.3	14.2	1.9	15	1.5	15.5	1.25	16	1.78	16.5	3.5
13.9	2.4	14.2	2.8	15	1.6	15.5	1.5	16	1.8	16.5	9
13.94	3.6	14.2	3	15	1.78	15.5	1.55	16	1.9	16.55	2.13
13.95	2.62	14.2	5.5	15	1.8	15.5	1.75	16	2	16.56	1.78
13.95	2.65	14.27	1.59	15	1.82	15.5	1.9	16	2.1	16.6	1
13.95	2.72	14.27	6.35	15	2	15.5	2	16	2.2	16.6	1.78
14	0.41	14.3	0.76	15	2.15	15.5	2.3	16	2.25	16.6	2.4
14	0.55	14.3	1.75	15	2.25	15.5	2.4	16	2.3	16.66	3.53
14	1	14.3	2	15	2.4	15.5	2.5	16	2.4	16.7	1.45

Dichtomatik dimensions

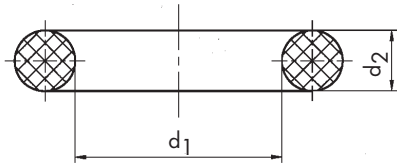

d1	d2	d1	d2	d1	d2	d1	d2
16.7	2.5	17.2	1.6	17.86	2.62	18.3	3
16.75	1.78	17.2	1.9	17.86	2.76	18.3	3.6
16.79	1	17.2	2.62	17.86	3.6	18.4	1.78
16.8	2.2	17.2	3	17.9	1.3	18.4	2.7
16.8	2.4	17.2	5.7	17.9	2.6	18.4	2.8
16.8	2.8	17.25	1.2	17.9	2.8	18.42	1.02
16.81	5.33	17.25	3	17.93	1.78	18.42	5.33
16.9	2.7	17.27	4.01	17.93	1.8	18.45	4.45
16.9	2.75	17.3	1	17.93	2.46	18.5	1
17	1	17.3	1.75	17.96	2.62	18.5	1.2
17	1.1	17.3	2.2	18	1	18.5	1.5
17	1.2	17.3	2.4	18	1.15	18.5	1.6
17	1.3	17.3	4	18	1.3	18.5	1.7
17	1.5	17.35	1.5	18	1.5	18.5	1.8
17	1.6	17.37	4.34	18	1.65	18.5	2
17	1.78	17.4	1.6	18	1.8	18.5	2.2
17	1.8	17.4	2.1	18	2	18.5	2.5
17	2	17.4	2.5	18	2.2	18.5	3
17	2.2	17.4	2.55	18	2.3	18.5	3.5
17	2.4	17.4	2.8	18	2.5	18.5	3.7
17	2.5	17.4	3.53	18	2.65	18.5	4.5
17	2.65	17.46	1.59	18	2.75	18.5	5.3
17	2.7	17.46	2.62	18	2.8	18.52	3.75
17	2.8	17.5	1	18	3	18.6	1.3
17	2.9	17.5	1.3	18	3.15	18.6	1.8
17	3	17.5	1.5	18	3.5	18.6	2.3
17	3.2	17.5	1.6	18	3.55	18.6	2.4
17	3.25	17.5	1.8	18	3.7	18.6	2.7
17	3.35	17.5	2	18	4	18.64	3.53
17	3.5	17.5	2.4	18	4.2	18.7	1.3
17	3.55	17.5	2.5	18	4.5	18.7	1.9
17	3.8	17.5	2.6	18	5	18.7	3
17	4	17.5	2.7	18	5.2	18.72	2.62
17	4.2	17.5	3	18	5.75	18.72	2.82
17	4.5	17.5	3.15	18	6	18.72	3.15
17	5	17.5	3.25	18	6.5	18.77	1.78
17	5.33	17.5	3.5	18	7	18.77	1.85
17	5.5	17.5	4	18	8	18.8	1.85
17	6	17.5	4.2	18	8.5	18.8	2
17	6.5	17.5	6.25	18	9	18.8	2.4
17	7	17.5	9	18	9.5	18.8	3
17	8	17.6	1	18	11	18.9	1.7
17	10	17.6	1.83	18.1	1.6	18.9	3
17	12	17.6	2.4	18.2	1.6	19	1
17.04	3.53	17.61	2.62	18.2	1.7	19	1.3
17.1	1.3	17.69	2.62	18.2	1.9	19	1.5
17.1	1.58	17.7	1	18.2	2.6	19	1.6
17.1	1.6	17.7	1.3	18.2	2.7	19	1.7
17.12	1.14	17.74	1.78	18.2	3	19	1.75
17.12	2.62	17.8	1.5	18.2	3.5	19	1.78
17.13	2.62	17.8	1.8	18.2	3.8	19	1.8
17.13	2.79	17.8	2.4	18.27	2.6	19	2
17.16	1.78	17.8	2.6	18.3	1.02	19	2.2
17.2	1	17.8	3	18.3	2.4	19	2.3
17.2	1.5	17.8	10	18.3	2.6	19	2.4

d1	d2	d1	d2	d1	d2	d1	d2	d1	d2	d1	d2
19	2.5	19.4	14	20	2.42	20.5	3	21.2	2.65	21.95	1.78
19	2.6	19.45	8	20	2.5	20.5	3.2	21.2	3	21.95	2
19	2.65	19.46	2.03	20	2.62	20.5	4	21.2	3.2	22	1
19	2.7	19.5	1	20	2.65	20.5	5	21.2	3.3	22	1.1
19	2.75	19.5	1.5	20	2.7	20.5	5.75	21.2	3.55	22	1.2
19	3	19.5	1.78	20	2.8	20.5	7.5	21.2	3.6	22	1.3
19	3.15	19.5	1.8	20	3	20.6	1.5	21.2	4	22	1.4
19	3.2	19.5	2	20	3.15	20.6	1.9	21.2	4.9	22	1.5
19	3.35	19.5	2.4	20	3.25	20.6	2.3	21.25	2.05	22	1.7
19	3.4	19.5	2.5	20	3.3	20.6	2.4	21.3	1	22	1.78
19	3.5	19.5	2.8	20	3.5	20.63	2.62	21.3	1.6	22	1.8
19	3.55	19.5	3	20	3.55	20.65	5.33	21.3	1.8	22	2
19	3.6	19.5	3.25	20	3.6	20.72	2.62	21.3	2.4	22	2.15
19	4	19.5	3.5	20	4	20.75	3.53	21.3	3.5	22	2.2
19	4.5	19.5	4	20	4.15	20.8	1.5	21.3	3.53	22	2.3
19	5	19.5	5.3	20	4.3	20.8	1.78	21.3	3.6	22	2.4
19	5.5	19.5	6	20	4.4	20.8	1.9	21.3	3.95	22	2.5
19	6	19.5	8	20	4.5	20.8	2.4	21.35	3	22	2.62
19	6.5	19.5	8.4	20	5	20.8	2.7	21.4	1.6	22	2.7
19	6.8	19.51	2.03	20	5.25	20.8	2.8	21.4	2.4	22	3
19	7	19.6	2.3	20	5.33	20.8	4	21.49	2.01	22	3.2
19	8	19.6	2.4	20	5.5	20.9	1.5	21.5	1	22	3.5
19	9	19.6	3	20	5.7	20.9	5.7	21.5	1.2	22	3.6
19	10	19.6	3.53	20	6	20.96	3.28	21.5	1.5	22	3.7
19.05	0.89	19.6	4	20	6.5	21	1	21.5	1.7	22	4
19.05	1.78	19.6	4.8	20	7	21	1.5	21.5	2	22	4.5
19.05	2.62	19.7	1.5	20	7.5	21	1.75	21.5	2.2	22	5
19.05	2.69	19.7	1.7	20	8	21	2	21.5	2.4	22	5.5
19.05	6.35	19.7	2	20	10	21	2.2	21.5	2.5	22	6
19.1	1.6	19.7	2.55	20	12	21	2.4	21.5	2.75	22	6.5
19.1	1.78	19.7	3.5	20.07	0.9	21	2.5	21.5	3	22	6.75
19.1	2.4	19.7	3.6	20.1	1.6	21	2.75	21.5	3.5	22	7
19.17	1.78	19.75	8	20.12	2	21	3	21.5	3.9	22	7.5
19.18	2.46	19.8	1.3	20.15	2.45	21	3.17	21.5	4	22	7.8
19.2	2	19.8	1.78	20.2	1.78	21	3.5	21.5	4.5	22	8
19.2	2.3	19.8	1.98	20.2	2.5	21	4	21.5	5	22	9
19.2	2.4	19.8	2.3	20.2	2.7	21	4.5	21.5	7.2	22	10
19.2	2.5	19.8	2.4	20.2	3	21	5	21.59	5.33	22	11
19.2	2.62	19.8	3.2	20.2	5.3	21	6	21.6	1.78	22	11.5
19.2	3	19.8	3.6	20.2	6	21	6.5	21.6	2	22.05	1.5
19.2	3.4	19.84	2.39	20.22	3.53	21	7	21.6	2.4	22.05	1.6
19.2	4	19.9	2.6	20.22	4.04	21	8	21.65	3.65	22.08	0.8
19.25	1.78	19.99	5.33	20.24	1.78	21	8.5	21.7	1	22.1	1.6
19.3	1.5	20	1	20.29	2.62	21	10	21.7	3.5	22.1	2
19.3	1.78	20	1.2	20.3	2.4	21	12	21.75	3.9	22.1	3.5
19.3	2.2	20	1.3	20.3	3	21.1	1.85	21.8	1.5	22.16	5.35
19.3	2.4	20	1.4	20.35	1.78	21.1	1.9	21.8	2.4	22.2	1.8
19.3	3.5	20	1.5	20.4	2.5	21.1	2.5	21.8	3	22.2	2
19.3	4.5	20	1.6	20.5	1	21.2	1.4	21.8	3.5	22.2	3
19.3	4.6	20	1.7	20.5	1.5	21.2	1.78	21.82	3.15	22.2	3.1
19.4	1.3	20	1.78	20.5	1.8	21.2	1.8	21.82	3.53	22.2	3.2
19.4	2.1	20	1.8	20.5	2	21.2	1.9	21.82	3.71	22.2	3.6
19.4	2.4	20	2	20.5	2.4	21.2	2.2	21.82	4.2	22.2	4.7
19.4	2.6	20	2.2	20.5	2.5	21.2	2.4	21.89	2.62	22.22	2.62
19.4	4.65	20	2.4	20.5	2.6	21.2	2.5	21.92	2.95	22.22	3.5

Dichtomatik dimensions

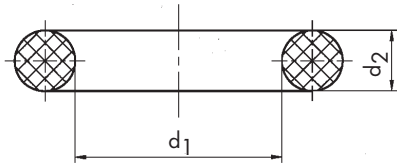

d1	d2	d1	d2	d1	d2	d1	d2
22.22	4.32	23	2.3	23.5	3.72	24	2.8
22.23	3.96	23	2.4	23.5	4	24	3
22.23	6.35	23	2.5	23.5	5	24	3.15
22.26	6.33	23	2.7	23.5	5.25	24	3.5
22.3	2.4	23	2.9	23.5	6	24	3.6
22.3	2.48	23	3	23.5	6.5	24	3.8
22.3	2.5	23	3.2	23.5	7.25	24	4
22.3	3	23	3.23	23.5	8.4	24	4.5
22.33	1.02	23	3.5	23.52	1.83	24	4.8
22.4	1.5	23	3.6	23.53	1.78	24	5
22.4	1.8	23	4	23.55	0.71	24	5.5
22.4	2.5	23	4.33	23.59	1	24	6
22.4	2.65	23	4.5	23.6	1.02	24	6.5
22.4	3.15	23	5	23.6	1.7	24	7
22.4	3.2	23	5.3	23.6	1.8	24	8
22.4	3.55	23	5.5	23.6	2	24	9
22.4	5	23	6	23.6	2.5	24	10
22.42	1.78	23	6.5	23.6	2.65	24	12.5
22.5	1	23	7	23.6	3.15	24	13
22.5	1.4	23	8	23.6	3.2	24.1	1.6
22.5	1.5	23	9	23.6	3.5	24.18	1.7
22.5	2	23	10	23.6	3.55	24.2	1.78
22.5	2.4	23	11	23.7	1.58	24.2	2.4
22.5	2.5	23	12.5	23.7	1.78	24.2	2.5
22.5	2.75	23	13	23.7	1.9	24.2	3
22.5	2.8	23	16	23.7	2.38	24.2	3.3
22.5	3	23.17	5.33	23.7	3.5	24.2	3.5
22.5	3.1	23.2	3.53	23.74	0.61	24.2	4.1
22.5	3.25	23.3	2	23.75	3.53	24.2	5.7
22.5	3.5	23.3	2.4	23.75	5	24.28	1.85
22.5	3.7	23.3	2.9	23.79	6.35	24.3	2.4
22.5	4	23.3	3	23.8	1.3	24.4	3
22.5	4.5	23.3	5.3	23.8	1.6	24.4	3.1
22.5	5	23.35	1.78	23.8	3.5	24.4	3.2
22.5	7	23.4	1.6	23.81	1.78	24.4	3.5
22.53	3.28	23.4	2.3	23.81	2.62	24.45	1.2
22.6	1.1	23.4	2.7	23.9	5	24.5	1
22.6	1.8	23.4	3.53	23.95	3.53	24.5	1.5
22.6	3.2	23.4	4.27	23.99	2.62	24.5	1.8
22.67	1.78	23.4	5.8	24	1	24.5	2
22.7	1.5	23.4	5.99	24	1.1	24.5	2.4
22.7	1.78	23.47	2.62	24	1.2	24.5	2.5
22.7	2.3	23.47	2.95	24	1.3	24.5	2.7
22.7	2.6	23.47	2.96	24	1.5	24.5	2.8
22.7	2.8	23.5	1	24	1.6	24.5	3
22.8	0.8	23.5	1.5	24	1.7	24.5	3.6
22.8	1.5	23.5	1.78	24	1.78	24.5	3
22.8	3.15	23.5	2	24	2	24.5	4
22.8	5.3	23.5	2.3	24	2.1	24.5	4.5
22.89	1	23.5	2.4	24	2.2	24.5	5.25
23	1	23.5	2.5	24	2.25	24.5	5.5
23	1.2	23.5	2.55	24	2.3	24.5	6
23	1.5	23.5	2.7	24	2.4	24.6	1.8
23	1.75	23.5	3	24	2.5	24.6	2.4
23	2	23.5	3.5	24	2.7	24.6	2.9
						24.6	3

d1	d2	d1	d2	d1	d2	d1	d2	d1	d2	d1	d2
24.6	3.15	25	5.7	25.5	5.5	26.34	5.33	27	8	27.8	5
24.6	3.4	25	6	25.6	1.78	26.4	5.2	27	12	27.8	8
24.6	3.5	25	6.5	25.6	5.49	26.5	1	27	13	27.93	5.33
24.6	3.6	25	7	25.67	1.78	26.5	1.2	27	16	28	1
24.64	2.62	25	7.5	25.7	1.5	26.5	1.5	27.1	1	28	1.3
24.66	1.78	25	8	25.7	1.9	26.5	1.7	27.1	1.6	28	1.5
24.7	1.7	25	9	25.7	3.5	26.5	1.8	27.2	5.7	28	1.6
24.7	2.67	25	10	25.8	1.8	26.5	2	27.28	3.53	28	1.7
24.7	3	25	12	25.8	2.65	26.5	2.3	27.3	2.4	28	1.8
24.7	3.5	25	13	25.8	3.2	26.5	2.5	27.3	2.5	28	1.9
24.76	2.62	25	14	25.8	3.53	26.5	2.65	27.3	2.7	28	2
24.77	5	25	15	25.8	3.55	26.5	3	27.3	3.2	28	2.2
24.77	5.33	25	15.5	25.8	6.9	26.5	3.15	27.31	3.28	28	2.3
24.8	1	25.04	2.95	25.9	4.8	26.5	3.25	27.38	0.76	28	2.5
24.8	1.5	25.07	2.62	26	1	26.5	3.5	27.4	2.5	28	2.62
24.8	1.9	25.1	1.6	26	1.2	26.5	3.55	27.4	2.7	28	2.65
24.8	2.2	25.12	1.78	26	1.3	26.5	4	27.4	3	28	2.8
24.8	3.4	25.12	2	26	1.37	26.5	8	27.4	3.53	28	3
24.8	5.5	25.12	2.03	26	1.5	26.57	3	27.4	4	28	3.15
24.8	6	25.2	1.2	26	1.6	26.58	3.53	27.43	4.57	28	3.2
24.8	7	25.2	1.7	26	1.78	26.59	2.95	27.5	1	28	3.25
24.9	3.6	25.2	1.8	26	2	26.6	2.2	27.5	1.1	28	3.4
24.9	3.8	25.2	2.3	26	2.1	26.6	2.4	27.5	1.25	28	3.5
24.99	1.27	25.2	2.5	26	2.15	26.6	3.5	27.5	1.5	28	3.55
24.99	3.53	25.2	2.9	26	2.2	26.64	2.62	27.5	2	28	3.65
25	1	25.2	3	26	2.3	26.7	1.78	27.5	2.3	28	3.7
25	1.2	25.2	3.2	26	2.4	26.7	2.5	27.5	2.4	28	4
25	1.3	25.2	3.5	26	2.5	26.77	2.1	27.5	2.5	28	4.1
25	1.5	25.25	2.8	26	2.6	26.8	1.6	27.5	2.7	28	4.3
25	1.6	25.3	1.6	26	3	26.8	2.5	27.5	3	28	4.4
25	1.7	25.3	2.4	26	3.2	26.8	3	27.5	3.2	28	4.5
25	1.76	25.3	2.6	26	3.5	26.8	4	27.5	4	28	4.75
25	1.8	25.3	3	26	3.6	26.9	1.5	27.5	4.5	28	5
25	2	25.4	1.5	26	3.67	26.9	2	27.5	6	28	5.3
25	2.2	25.4	1.58	26	3.7	27	1	27.5	6.8	28	5.5
25	2.3	25.4	2.5	26	4	27	1.15	27.5	7.5	28	6
25	2.4	25.4	3.17	26	4.5	27	1.3	27.56	3.17	28	6.5
25	2.5	25.4	3.18	26	5	27	1.5	27.58	1.7	28	7
25	2.6	25.4	3.5	26	5.5	27	1.78	27.6	1.78	28	8
25	2.65	25.4	3.53	26	6	27	2	27.6	2.2	28	8.5
25	3	25.4	4	26	6.5	27	2.2	27.6	2.4	28	8.75
25	3.15	25.4	6.35	26	7	27	2.5	27.6	6	28	10
25	3.2	25.5	1	26	8	27	2.7	27.7	2.4	28	11
25	3.3	25.5	1.2	26	8.75	27	3	27.7	2.7	28	12
25	3.5	25.5	1.6	26	9	27	3.2	27.7	3.4	28.1	2.62
25	3.55	25.5	1.78	26	10	27	3.5	27.7	3.5	28.1	4.3
25	3.6	25.5	1.8	26	12	27	4	27.8	1.5	28.15	3.2
25	3.7	25.5	2	26.07	2.62	27	4.5	27.8	1.78	28.17	3.53
25	4	25.5	2.5	26.2	2.3	27	5	27.8	2	28.17	3.73
25	4.15	25.5	3	26.2	3	27	5.25	27.8	2.62	28.2	1
25	4.3	25.5	3.2	26.2	3.6	27	5.33	27.8	3	28.2	3
25	4.5	25.5	3.5	26.25	2.35	27	5.5	27.8	3.2	28.2	5.3
25	5	25.5	3.7	26.3	2	27	6	27.8	3.5	28.25	2.62
25	5.33	25.5	4.5	26.3	2.4	27	6.5	27.8	3.53	28.3	1
25	5.5	25.5	5	26.33	2	27	7	27.8	3.6	28.3	1.6

Dichtomatik dimensions

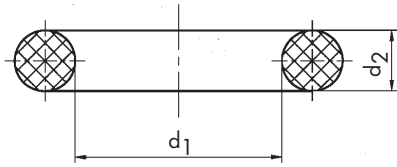

d1	d2	d1	d2	d1	d2	d1	d2
28.3	1.78	29.1	2.55	30	1.8	30.5	7
28.3	1.8	29.1	3	30	1.82	30.5	15
28.3	2	29.2	2.62	30	2	30.6	1
28.3	2.4	29.2	3	30	2.2	30.7	3.5
28.3	2.7	29.2	3.3	30	2.3	30.75	1
28.3	3.1	29.2	3.5	30	2.4	30.8	1.78
28.3	3.55	29.2	4.7	30	2.5	30.8	2.5
28.4	3	29.25	1.6	30	2.65	30.8	3.53
28.42	2.62	29.28	2.8	30	2.7	30.8	3.6
28.45	3.18	29.3	1	30	2.8	30.8	3.7
28.5	1	29.3	1.78	30	3	30.8	4.5
28.5	1.5	29.3	2.62	30	3.1	30.81	3.78
28.5	1.8	29.3	3.6	30	3.15	30.95	2.64
28.5	2	29.4	1	30	3.2	31	1.5
28.5	2.5	29.4	3	30	3.5	31	1.7
28.5	3	29.4	3.1	30	3.55	31	2
28.5	3.3	29.45	4.39	30	3.6	31	2.1
28.5	3.5	29.5	1	30	3.7	31	2.2
28.5	4	29.5	1.2	30	4	31	2.5
28.5	4.25	29.5	1.5	30	4.3	31	3
28.5	4.5	29.5	2	30	4.4	31	3.5
28.56	2.38	29.5	2.3	30	4.5	31	3.7
28.6	1.6	29.5	2.5	30	4.8	31	3.8
28.6	2.2	29.5	2.7	30	5	31	4
28.6	3.5	29.5	3	30	5.33	31	4.5
28.7	3.5	29.5	3.15	30	5.5	31	4.7
28.75	3.53	29.5	3.5	30	5.7	31	5
28.8	2.5	29.5	3.6	30	5.8	31	5.3
28.8	3.2	29.5	4.5	30	6	31	5.5
28.8	3.53	29.5	5	30	6.5	31	6
28.87	1.78	29.5	5.7	30	7	31	6.4
28.88	3.28	29.5	8.5	30	7.5	31	6.5
28.9	3	29.51	5.33	30	8	31	8
28.9	3.1	29.6	2.4	30	9	31	9
28.9	3.6	29.69	1.14	30	10	31	9.5
29	1	29.7	1	30	11	31	10
29	1.5	29.7	2.7	30	12	31	12
29	1.78	29.7	2.8	30	13	31	14
29	1.8	29.7	3	30	17.5	31	15
29	2	29.7	3.5	30.1	2.62	31	18.5
29	2.5	29.74	2.95	30.16	2.38	31.1	0.8
29	3	29.75	1	30.2	1	31.1	1.4
29	3.15	29.75	3.53	30.2	3	31.12	5.33
29	3.3	29.8	1	30.2	3.6	31.14	0.79
29	3.5	29.8	3.2	30.23	1.27	31.2	2.4
29	4	29.8	4.5	30.3	2.4	31.2	3
29	4.5	29.82	2.62	30.3	5.7	31.2	3.5
29	5	29.87	1.52	30.35	3.6	31.2	4.7
29	6	29.87	1.78	30.43	1.78	31.3	2
29	8	29.9	1	30.5	1	31.3	3.5
29	8.3	29.9	3.53	30.5	1.5	31.34	1.98
29	8.5	29.92	2.62	30.5	2	31.34	3.53
29	10	30	1	30.5	2.5	31.4	5
29	16	30	1.2	30.5	3	31.42	1.5
29.1	1.6	30	1.5	30.5	5	31.42	1.78

d1	d2	d1	d2	d1	d2	d1	d2	d1	d2	d1	d2
31.42	2.6	32	2.6	32.6	1.2	33.5	1	34	4	34.65	1.78
31.42	2.62	32	2.7	32.6	1.8	33.5	1.5	34	4.1	34.7	2.8
31.42	2.8	32	2.8	32.6	2.4	33.5	1.6	34	4.5	34.7	3.5
31.47	1.78	32	3	32.69	5.33	33.5	1.8	34	4.7	34.7	4.3
31.5	1.2	32	3.2	32.7	1.3	33.5	2	34	5	34.8	3
31.5	1.5	32	3.5	32.7	1.5	33.5	2.5	34	5.5	35	1
31.5	1.75	32	3.53	32.7	3	33.5	2.65	34	5.75	35	1.2
31.5	1.8	32	3.6	32.7	5.33	33.5	2.8	34	6	35	1.25
31.5	1.95	32	4	32.7	6.5	33.5	3	34	7	35	1.5
31.5	2	32	4.2	32.9	5.3	33.5	3.15	34	7.5	35	1.9
31.5	2.5	32	4.5	32.92	3.53	33.5	3.5	34	8	35	2
31.5	2.65	32	5	32.92	5.33	33.5	3.55	34	10	35	2.1
31.5	3	32	5.5	32.92	5.53	33.5	4	34	11	35	2.15
31.5	3.15	32	5.7	33	1	33.5	4.6	34	12	35	2.2
31.5	3.3	32	6	33	1.2	33.5	5	34.1	3	35	2.5
31.5	3.5	32	6.2	33	1.5	33.5	5.2	34.1	3.6	35	2.6
31.5	3.55	32	6.5	33	1.78	33.5	6	34.2	2	35	2.8
31.5	3.65	32	7	33	2	33.5	7	34.2	2.3	35	3
31.5	4	32	8	33	2.5	33.5	13	34.2	2.8	35	3.1
31.5	4.5	32	9	33	2.62	33.55	3.71	34.2	3	35	3.2
31.5	5	32	10	33	2.8	33.6	1.78	34.2	3.3	35	3.3
31.5	5.3	32	12	33	3	33.6	2.7	34.29	1.19	35	3.5
31.5	6	32	13.5	33	3.5	33.6	4	34.29	5.33	35	3.6
31.5	6.5	32	14	33	4	33.6	6	34.3	2.5	35	4
31.6	1.32	32	16	33	4.5	33.7	2	34.3	4.6	35	4.25
31.6	1.6	32.05	1.55	33	5	33.7	2.2	34.3	5	35	4.5
31.6	2.4	32.1	1.6	33	5.2	33.7	3	34.4	3.1	35	5
31.63	2	32.11	3.45	33	5.7	33.7	3.5	34.42	2.95	35	5.3
31.7	3.2	32.15	3.53	33	6	33.7	3.7	34.5	1	35	5.33
31.7	3.5	32.2	1.4	33	6.5	33.71	3.53	34.5	1.5	35	6
31.74	1.78	32.2	2.5	33	7	33.77	2.65	34.5	1.7	35	7
31.75	1.57	32.2	3	33	7.5	33.99	2.34	34.5	1.8	35	8
31.75	1.6	32.2	4	33	8	34	1	34.5	2	35	9
31.75	2.03	32.21	1.78	33	9	34	1.1	34.5	2.35	35	10
31.75	3.17	32.3	2	33	10	34	1.2	34.5	2.4	35	12
31.75	6.35	32.3	5.7	33	12	34	1.4	34.5	2.5	35	15
31.8	1	32.4	2.1	33	14	34	1.5	34.5	2.65	35	21
31.8	1.4	32.4	3	33.05	1.78	34	1.6	34.5	3	35.1	1
31.8	1.5	32.5	1.5	33.12	1.52	34	1.7	34.5	3.5	35.1	1.6
31.8	1.6	32.5	1.7	33.12	3.53	34	1.75	34.5	3.55	35.2	1
31.8	3.2	32.5	1.8	33.2	1.3	34	1.9	34.5	3.65	35.2	2.4
31.8	3.5	32.5	2	33.2	2.4	34	2	34.5	3.7	35.2	2.5
32	1	32.5	2.2	33.2	3.5	34	2.1	34.5	4	35.2	2.62
32	1.1	32.5	2.4	33.21	3.53	34	2.16	34.5	4.5	35.2	3
32	1.25	32.5	2.5	33.27	1.58	34	2.3	34.5	5	35.2	3.5
32	1.3	32.5	2.6	33.27	1.78	34	2.4	34.5	5.5	35.2	4
32	1.5	32.5	2.65	33.3	1.3	34	2.5	34.5	7	35.2	5
32	1.6	32.5	2.85	33.3	2	34	2.6	34.52	3.53	35.2	5.7
32	1.78	32.5	3	33.3	2.4	34	3	34.57	1.25	35.3	2.4
32	1.8	32.5	3.5	33.3	2.6	34	3.2	34.59	2.62	35.3	2.5
32	2	32.5	3.55	33.3	4	34	3.25	34.6	1.78	35.3	4.5
32	2.2	32.5	3.6	33.32	3.53	34	3.5	34.6	2.4	35.3	4.9
32	2.3	32.5	4	33.34	2.38	34	3.6	34.6	2.6	35.31	2.62
32	2.4	32.5	5	33.4	2	34	3.75	34.6	4	35.4	2.2
32	2.5	32.5	5.7	33.4	3	34	3.8	34.62	2	35.4	3

Dichtomatik dimensions

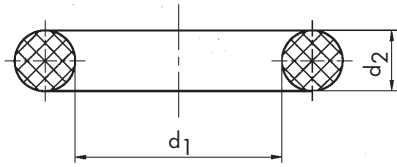

d1	d2	d1	d2	d1	d2	d1	d2
35.4	3.1	36.1	3.53	37	4.5	38	1
35.4	3.2	36.17	1.02	37	5	38	1.2
35.4	3.25	36.17	1.78	37	5.3	38	1.5
35.5	1	36.17	2.38	37	5.5	38	1.7
35.5	1.5	36.17	2.62	37	6	38	1.8
35.5	1.78	36.2	1.52	37	8	38	2
35.5	1.8	36.2	1.57	37	10	38	2.4
35.5	2	36.2	1.8	37.1	1	38	2.5
35.5	2.5	36.2	2	37.1	1.6	38	2.6
35.5	2.65	36.2	2.4	37.1	1.8	38	2.7
35.5	3	36.2	2.6	37.1	2.1	38	3
35.5	3.15	36.2	2.65	37.1	2.62	38	3.5
35.5	3.55	36.2	3	37.2	2.5	38	3.6
35.5	4	36.2	3.7	37.2	3	38	4
35.5	4.5	36.2	5.7	37.2	3.53	38	4.5
35.5	6.4	36.25	1.14	37.2	3.6	38	5
35.5	11.5	36.27	1.78	37.2	4.1	38	5.2
35.5	16.5	36.36	2.62	37.2	5.7	38	5.3
35.52	2.53	36.4	3.8	37.21	2.62	38	5.5
35.6	3.6	36.5	1	37.3	1.5	38	6
35.7	2.62	36.5	1.5	37.3	3.5	38	6.5
35.7	3.5	36.5	1.8	37.3	3.6	38	7
35.76	1.02	36.5	2	37.4	4.5	38	7.1
35.8	1	36.5	2.5	37.42	3	38	8
35.97	1.78	36.5	2.65	37.46	3	38	9
36	1	36.5	3	37.47	3	38	10
36	1.3	36.5	3.5	37.47	5.33	38	12
36	1.5	36.5	3.55	37.5	1.25	38	20
36	1.78	36.5	3.75	37.5	1.5	38.1	1.35
36	1.8	36.5	6	37.5	2	38.1	1.59
36	2	36.51	6.99	37.5	2.5	38.1	3.18
36	2.2	36.6	1.6	37.5	2.65	38.1	6.35
36	2.3	36.6	2.2	37.5	3	38.1	11.1
36	2.5	36.6	2.5	37.5	3.15	38.12	2.39
36	2.7	36.6	3	37.5	3.5	38.2	2
36	3	36.7	2	37.5	3.55	38.2	3.6
36	3.2	36.8	1	37.5	4	38.2	4.7
36	3.5	36.8	1.2	37.5	4.5	38.2	5
36	3.53	36.8	3	37.5	5.3	38.35	1.27
36	3.8	36.83	3.28	37.6	1.2	38.4	1.6
36	4	36.9	1.2	37.6	2.4	38.4	2
36	4.5	36.9	5.3	37.6	4.5	38.5	1.5
36	4.6	36.91	1.19	37.69	3.53	38.5	1.93
36	5	37	1	37.7	3	38.5	2
36	5.37	37	1.2	37.7	3.5	38.5	2.3
36	5.5	37	1.5	37.7	4	38.5	2.5
36	5.7	37	1.8	37.7	5.3	38.5	3
36	6	37	2	37.7	5.53	38.5	3.5
36	6.5	37	2.4	37.77	2.62	38.5	6.3
36	7	37	2.5	37.8	2	38.5	8.5
36	8	37	2.6	37.8	2.38	38.7	2.65
36	9	37	3	37.82	1.6	38.7	2.8
36	10	37	3.5	37.82	1.78	38.7	3.5
36	11	37	3.6	37.82	2	38.7	3.55
36.07	1.78	37	4	37.9	3.51	38.7	5.3

d1	d2	d1	d2	d1	d2	d1	d2	d1	d2	d1	d2
38.86	1.19	39.5	8.5	40	18	41.2	1.8	42	4.2	43	1.5
38.9	1.45	39.5	10	40.04	2.62	41.2	2.65	42	4.5	43	1.6
39	1	39.6	2.4	40.06	2.7	41.2	3	42	5	43	1.8
39	1.2	39.6	3.7	40.2	1.75	41.2	3.55	42	5.2	43	2
39	1.5	39.69	2.38	40.2	3	41.2	4.7	42	5.4	43	2.2
39	1.6	39.69	3.53	40.2	5.3	41.2	5.3	42	5.5	43	2.5
39	1.78	39.7	3.5	40.3	2.4	41.2	5.7	42	5.6	43	2.8
39	2	39.7	3.6	40.5	2	41.28	1.59	42	6	43	3
39	2.2	39.7	4.35	40.5	2.4	41.28	3.53	42	6.4	43	3.2
39	2.5	39.76	3	40.5	2.5	41.3	1.6	42	7	43	3.5
39	3	39.8	2.2	40.5	3	41.3	1.8	42	7.5	43	4
39	3.2	39.9	3.53	40.5	3.4	41.3	2.62	42	8	43	4.5
39	3.5	40	1	40.5	3.5	41.3	2.7	42	9	43	5
39	4	40	1.2	40.5	4.5	41.3	3.17	42	10	43	5.2
39	4.3	40	1.25	40.5	5	41.3	3.2	42	11	43	5.5
39	4.5	40	1.5	40.5	5.5	41.3	4	42	11.7	43	6
39	5	40	1.6	40.5	6	41.37	1.78	42	12	43	6.5
39	5.3	40	1.8	40.59	2.62	41.4	5.3	42	13	43	8
39	5.5	40	2	40.6	3.2	41.5	1.5	42	14	43	9
39	6	40	2.2	40.6	3.53	41.5	1.6	42	16	43	10
39	6.2	40	2.4	40.65	5.33	41.5	2.9	42	20	43	11
39	6.3	40	2.5	40.7	3	41.5	3	42.2	1.5	43	12
39	6.5	40	2.65	40.7	3.5	41.5	3.15	42.2	1.8	43	16
39	7.2	40	2.8	40.8	3.5	41.5	3.5	42.2	3	43	20
39	8	40	3	40.8	3.8	41.5	4	42.2	5.7	43.2	2
39	10	40	3.15	40.8	4.7	41.5	4.5	42.4	1.2	43.2	3
39.1	1.3	40	3.2	40.87	3.53	41.5	6	42.4	4.13	43.4	1.8
39.2	1.9	40	3.3	40.95	2.62	41.6	1.6	42.4	5.33	43.4	3.6
39.2	2	40	3.5	40.99	5.33	41.6	1.78	42.42	1.78	43.5	3
39.2	2.5	40	3.55	41	1	41.6	2.4	42.5	1.78	43.5	4
39.2	3	40	3.75	41	1.2	41.7	3.5	42.5	1.8	43.5	5.3
39.2	3.7	40	3.9	41	1.4	41.7	4.05	42.5	2.65	43.5	5.4
39.2	3.9	40	4	41	1.5	41.7	4.13	42.5	3	43.55	3.55
39.2	5	40	4.5	41	1.6	41.8	2.6	42.5	3.15	43.69	2.62
39.2	5.7	40	5	41	1.75	41.82	3.53	42.5	3.2	43.69	3
39.2	6	40	5.2	41	1.78	41.83	2.79	42.5	3.5	43.69	3.5
39.34	2.62	40	5.25	41	1.8	41.9	3	42.5	3.55	43.7	1.8
39.37	2.34	40	5.3	41	2	41.91	6.35	42.5	4	43.7	2.8
39.4	1.6	40	5.35	41	2.5	42	1	42.5	4.3	43.7	3
39.4	3.1	40	5.5	41	3	42	1.2	42.5	5.3	43.7	3.5
39.4	6.6	40	5.72	41	3.5	42	1.5	42.5	8	43.7	3.55
39.4	10	40	5.9	41	4	42	1.6	42.5	8.3	43.7	5.3
39.45	1.78	40	6	41	4.5	42	1.78	42.52	2.62	43.8	1.78
39.49	3.53	40	6.4	41	4.6	42	2	42.57	3.53	43.8	4.1
39.5	1.2	40	6.5	41	5	42	2.25	42.6	4	43.82	5.33
39.5	1.5	40	7	41	5.5	42	2.3	42.8	3.53	43.92	2.9
39.5	2	40	7.5	41	6	42	2.5	42.8	3.7	43.99	1.5
39.5	2.4	40	8	41	6.5	42	2.6	42.8	5.33	43.99	2.01
39.5	2.5	40	9	41	7	42	2.7	42.86	3.53	44	1
39.5	3	40	10	41	7.5	42	3	42.86	4.36	44	1.3
39.5	3.2	40	11	41	8	42	3.15	42.86	6.35	44	1.5
39.5	3.25	40	12	41	15	42	3.2	42.9	4.82	44	2
39.5	3.5	40	13	41	21	42	3.5	42.96	3.53	44	2.5
39.5	5.5	40	15	41.1	5.8	42	3.8	43	1	44	2.6
39.5	6	40	16	41.2	1.6	42	4	43	1.3	44	2.8

Dichtomatik dimensions

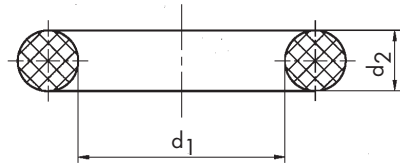

d1	d2	d1	d2	d1	d2	d1	d2
44	3	44.6	2.4	45.7	3.5	47	1.5
44	3.15	44.7	2.9	45.72	1.78	47	1.6
44	3.17	44.7	3	45.84	1.78	47	2
44	3.5	44.7	3.5	46	1	47	2.13
44	3.65	44.8	3.5	46	1.1	47	2.5
44	3.7	44.99	1.78	46	1.2	47	2.6
44	4	45	1	46	1.5	47	2.7
44	4.2	45	1.2	46	2	47	3
44	4.5	45	1.5	46	2.2	47	3.2
44	5	45	1.6	46	2.4	47	3.5
44	5.25	45	2	46	2.5	47	3.7
44	5.34	45	2.5	46	2.6	47	4
44	5.5	45	2.62	46	3	47	4.5
44	6	45	2.75	46	3.2	47	5
44	6.5	45	2.8	46	3.5	47	5.33
44	7	45	3	46	4	47	5.5
44	8	45	3.15	46	4.5	47	6
44	9	45	3.5	46	5	47	6.5
44	11	45	3.55	46	5.34	47	6.7
44	12	45	3.75	46	5.5	47	7
44.04	3.53	45	4	46	6	47	7.5
44.1	1.6	45	4.5	46	7	47	8
44.1	2.6	45	4.8	46	8	47	9
44.12	2.5	45	5	46	10	47	10
44.12	2.62	45	5.3	46	11	47	12
44.17	1.78	45	5.5	46	22	47	16.5
44.2	2	45	6	46.04	3.53	47.11	1
44.2	2.5	45	6.4	46.1	2.4	47.2	1.5
44.2	3	45	6.5	46.2	2	47.2	2.4
44.2	3.3	45	7	46.2	3	47.2	3.3
44.2	3.7	45	7.5	46.2	3.5	47.2	3.5
44.2	5.1	45	8	46.2	3.55	47.2	5.7
44.2	5.7	45	8.5	46.2	5.3	47.22	3.53
44.2	6.7	45	9	46.2	5.33	47.22	5.53
44.2	7.5	45	10	46.4	4.6	47.24	4.27
44.3	5.7	45	12	46.4	5.3	47.29	2.62
44.4	3.1	45	15	46.4	5.4	47.35	1.27
44.4	3.17	45	25	46.5	1.8	47.37	1.78
44.4	4.8	45.2	2.4	46.5	2.5	47.4	4
44.4	5.33	45.2	2.8	46.5	3.5	47.4	4.8
44.45	2.62	45.2	3	46.5	4	47.5	1.5
44.45	3.53	45.2	5.7	46.5	5	47.5	1.8
44.5	1.6	45.3	5.7	46.5	5.33	47.5	2.5
44.5	2	45.36	3.53	46.5	5.7	47.5	2.65
44.5	2.15	45.4	6.5	46.5	6	47.5	2.7
44.5	2.4	45.5	1.2	46.5	7.2	47.5	3
44.5	2.5	45.5	1.5	46.69	2.62	47.5	3.15
44.5	3	45.5	5.5	46.7	1.78	47.5	3.18
44.5	3.18	45.5	6.8	46.7	2.5	47.5	3.2
44.5	3.5	45.6	1.2	46.8	4.1	47.5	3.55
44.5	4.8	45.6	1.5	46.99	1.14	47.5	4
44.5	5.5	45.62	3.53	46.99	3.67	47.5	4.5
44.5	6	45.69	2.62	46.99	5.33	47.5	5.3
44.5	6.25	45.69	3.53	46.99	5.97	47.5	5.33
44.5	8.5	45.7	1.5	47	1	47.5	5.5

d1	d2	d1	d2	d1	d2	d1	d2	d1	d2	d1	d2
47.5	5.75	48.2	1.2	49.5	5	50.2	3	52	1	53	3.55
47.5	6	48.25	4	49.5	5.5	50.3	2.4	52	1.5	53	3.6
47.5	6.5	48.3	3.2	49.5	6.25	50.4	2.62	52	2	53	4
47.55	1.78	48.32	5.33	49.6	2.4	50.4	3.53	52	2.4	53	4.5
47.55	3.55	48.38	2.62	49.6	3.5	50.47	2.62	52	2.5	53	5
47.6	2.4	48.4	3.5	49.6	5.7	50.5	2.4	52	2.7	53	5.3
47.6	3.53	48.5	1.5	49.65	1.78	50.5	3	52	2.8	53	5.5
47.6	3.6	48.5	3.5	49.7	3.5	50.5	6.3	52	3	53	5.7
47.6	4	48.5	4	49.7	5.3	50.52	1.78	52	3.3	53	5.8
47.6	5.7	48.5	5.8	49.7	5.7	50.8	1.6	52	3.5	53	6
47.6	9.5	48.5	7	49.8	1.8	50.8	1.78	52	3.9	53	7
47.63	3.18	48.7	2.65	50	1	50.8	3.18	52	4	53	10
47.63	3.53	48.7	3.5	50	1.2	50.8	3.2	52	4.5	53	12
47.63	6.99	48.7	3.53	50	1.5	50.8	3.53	52	5	53	14
47.65	1.57	48.7	3.55	50	2	50.8	5.1	52	5.33	53	16
47.7	1.5	48.7	5.3	50	2.35	50.8	6.35	52	5.5	53.09	3
47.7	2.62	48.8	4	50	2.4	50.9	2.4	52	6	53.1	3
47.7	3.5	48.9	2.62	50	2.5	51	1.5	52	6.5	53.19	3.53
47.7	4.75	49	1	50	2.7	51	2	52	7.5	53.25	4
47.8	3	49	1.5	50	2.8	51	2.5	52	8	53.28	0.99
47.96	2.36	49	1.6	50	3	51	3	52	9	53.3	3.53
48	1	49	1.7	50	3.25	51	3.2	52	10	53.3	5.3
48	1.2	49	2	50	3.5	51	3.5	52	12	53.34	2.44
48	1.5	49	2.5	50	3.55	51	3.6	52.07	2.62	53.34	5.33
48	1.55	49	3	50	3.6	51	3.8	52.1	1	53.4	3.5
48	1.7	49	3.5	50	3.85	51	4	52.2	3	53.5	1.2
48	1.78	49	4	50	4	51	4.3	52.2	5.7	53.5	1.5
48	1.8	49	4.5	50	4.5	51	4.5	52.3	1.7	53.5	3
48	2	49	5	50	4.7	51	5	52.3	5.7	53.5	3.53
48	2.5	49	5.3	50	4.8	51	5.2	52.39	3.53	53.5	4
48	2.6	49	5.5	50	5	51	5.5	52.4	5.3	53.5	5.8
48	2.62	49	6	50	5.2	51	6	52.5	1.78	53.5	9
48	2.75	49	6.25	50	5.3	51	9	52.5	1.8	53.52	2.62
48	3	49	7	50	5.33	51	9.5	52.5	2.2	53.57	3.53
48	3.5	49	9	50	5.5	51	10	52.5	3	53.6	2.6
48	3.65	49	12	50	5.7	51	12	52.5	3.5	53.6	3.17
48	4	49.1	5.8	50	6	51	12.5	52.5	4.5	53.6	3.53
48	4.2	49.15	1.78	50	6.5	51.05	1.78	52.5	5.2	53.6	5.64
48	4.5	49.2	1.8	50	7	51.1	1.6	52.5	5.7	53.64	2.65
48	5	49.2	2.4	50	7.5	51.2	3.6	52.5	6.9	53.65	2.62
48	5.3	49.2	3	50	8	51.2	5.3	52.54	5.33	53.67	1.78
48	5.5	49.2	4	50	8.5	51.2	5.7	52.6	1.75	53.8	4
48	6	49.2	4.5	50	9	51.5	1.5	52.6	2.4	53.97	4.76
48	6.1	49.2	5.7	50	10	51.5	2	52.6	2.8	53.98	3.53
48	6.5	49.2	6.3	50	11	51.5	2.1	52.6	3.5	53.98	6.35
48	7	49.21	3.53	50	12	51.5	3.55	52.6	5.7	54	1
48	8	49.22	3.96	50	13.5	51.5	4.5	52.75	1.78	54	1.5
48	9	49.3	5.7	50	15	51.5	5.3	52.9	5.33	54	2
48	10	49.4	2.8	50	16	51.6	2.4	53	1	54	2.3
48	11	49.4	3.1	50.1	3.2	51.6	4.6	53	1.2	54	2.5
48	12	49.44	3.53	50.1	3.3	51.6	5.7	53	1.5	54	2.65
48	13	49.5	2.5	50.16	5.33	51.7	5.3	53	2	54	3
48	16	49.5	3	50.17	1.78	51.8	3	53	2.5	54	3.17
48	22	49.5	3.5	50.17	6.99	51.94	3.53	53	3	54	3.2
48.1	1.2	49.5	4.5	50.2	2.5	51.99	2.77	53	3.5	54	3.5

Dichtomatik dimensions

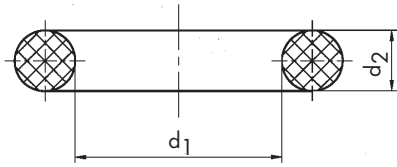

d1	d2	d1	d2	d1	d2	d1	d2
54	4	55	6.5	56.16	5.33	57.3	1.5
54	4.5	55	7	56.16	5.34	57.3	5.2
54	4.75	55	7.5	56.2	3	57.5	5
54	5	55	8	56.2	3.4	57.5	10
54	5.5	55	10	56.4	2.5	57.53	2.08
546		55	13	56.5	1.7	57.53	3.35
54	6.3	55	13.5	56.5	2.4	57.6	1.4
54	6.5	55.2	2	56.5	2.45	57.6	2.4
54	7	55.2	3	56.5	3.1	57.6	3.3
54	8	55.2	5.7	56.5	3.5	57.6	5.7
54	9.5	55.25	1.78	56.5	4	57.61	2.16
54	12	55.25	2.62	56.5	5.33	57.65	3.53
54	20	55.3	5.7	56.5	7	57.75	4
54.1	3.18	55.35	2.62	56.5	15	57.8	2.6
54.1	3.7	55.5	1.78	56.52	5.33	57.84	6.35
54.2	1.65	55.5	3	56.6	2.4	58	1
54.2	2.3	55.52	2.62	56.7	2.8	58	1.5
54.2	3	55.56	3.53	56.74	3.53	58	2
54.2	5.3	55.6	5.7	56.74	5.53	58	2.5
54.2	5.7	55.7	2.5	56.79	2.92	58	2.67
54.3	3	55.7	3.75	56.8	6	58	3
54.3	5.7	55.7	4	56.82	2.62	58	3.2
54.4	3.1	55.8	2.1	56.87	1.78	58	3.5
54.4	4.13	55.88	2.03	57	1	58	3.55
54.5	2.5	55.9	2.4	57	1.3	58	4
54.5	2.7	56	1	57	1.5	58	4.2
54.5	3	56	1.4	57	2	58	4.5
54.5	3.55	56	1.5	57	2.5	58	5
54.5	5.5	56	1.78	57	2.6	58	5.3
54.5	7	56	1.8	57	3	58	5.5
54.6	2.4	56	2	57	3.5	58	5.8
54.6	5.7	56	2.3	57	3.53	58	6
54.7	1.4	56	2.4	57	4	58	6.5
54.75	2	56	2.5	57	4.5	58	7
55	1	56	3	57	5	58	7.5
55	1.2	56	3.15	57	5.5	58	8
55	1.5	56	3.2	57	5.7	58	9
55	1.78	56	3.5	57	6	58	10
55	1.8	56	3.55	57	6.5	58	20
55	2	56	4	57	7	58	23
55	2.5	56	4.3	57	8	58.2	3.1
55	2.6	56	4.5	57	9	58.39	1.78
55	3	56	5	57	9.5	58.4	1.3
55	3.2	56	5.2	57	10	58.42	2.62
55	3.5	56	5.3	57	15	58.44	1.78
55	3.7	56	5.5	57	17	58.5	1.25
55	4	56	6	57.1	1.78	58.5	3
55	4.5	56	6.3	57.1	3.2	58.5	3.5
55	4.7	56	6.5	57.14	3.28	58.5	5
55	4.8	56	6.8	57.15	2.03	58.5	5.33
55	5	56	7	57.15	2.24	58.5	5.7
55	5.2	56	7.5	57.15	3.53	58.5	6.2
55	5.33	56	8	57.2	1.6	58.5	6.5
55	5.5	56	10	57.2	3	58.6	3
55	6	56	12	57.2	5.7	58.6	7

d1	d2	d1	d2	d1	d2	d1	d2	d1	d2	d1	d2
58.7	5.5	60	1.8	60.8	2	62	5	63	6	64	4.5
58.72	6.35	60	2	61	1	62	5.2	63	6.5	64	4.8
58.74	3.53	60	2.2	61	1.5	62	5.5	63	7	64	5
58.75	6.36	60	2.3	61	1.6	62	5.7	63	7.5	64	5.33
58.8	4.2	60	2.5	61	2	62	6	63	8	64	5.5
58.8	6	60	2.62	61	2.5	62	6.5	63	9	64	5.7
58.8	6.2	60	2.65	61	3	62	7	63	10	64	6
58.88	2.62	60	2.8	61	3.2	62	8	63	14	64	6.5
59	1	60	3	61	3.5	62	8.5	63	15	64	7
59	1.5	60	3.15	61	4	62	9	63	16	64	8
59	2	60	3.2	61	4.3	62	10	63.09	3.53	64	9.27
59	2.4	60	3.3	61	4.5	62	11	63.09	3.8	64	9.5
59	2.5	60	3.5	61	5	62	12	63.1	2.2	64	10
59	2.7	60	3.55	61	5.9	62	14	63.1	2.4	64	11
59	3	60	3.65	61	6	62	15	63.12	3.63	64	16
59	3.5	60	4	61	8.5	62	18	63.17	2.62	64.2	1.6
59	4	60	4.2	61	9	62.1	2.62	63.22	1.5	64.2	1.9
59	5	60	4.5	61	10	62.2	3	63.22	1.75	64.2	5
59	5.5	60	4.6	61	12.5	62.2	5.7	63.22	1.78	64.2	5.7
59	6	60	4.8	61.01	2.49	62.23	4.06	63.3	10.75	64.3	1.5
59	6.5	60	5	61.2	1.5	62.3	3.2	63.46	2.89	64.3	5.7
59	7	60	5.3	61.2	4.2	62.3	5.7	63.49	9.53	64.39	1.78
59	10	60	5.34	61.2	5.7	62.33	1.78	63.5	2.7	64.4	3
59	11	60	5.4	61.24	3.53	62.4	2.8	63.5	3.1	64.4	3.1
59	12	60	5.5	61.3	1.78	62.4	4	63.5	3.15	64.4	3.15
59.1	5.8	60	5.7	61.5	1.5	62.4	5.3	63.5	3.2	64.4	4.5
59.18	1.02	60	6	61.5	1.78	62.5	1.3	63.5	3.53	64.47	2.62
59.2	5.33	60	7	61.5	2	62.5	1.8	63.5	3.7	64.5	1.5
59.2	5.7	60	7.5	61.5	2.5	62.5	2.3	63.5	4	64.5	1.8
59.2	11.2	60	8	61.5	2.65	62.5	2.5	63.5	4.3	64.5	2
59.3	3.73	60	8.5	61.5	3.55	62.5	5	63.5	4.5	64.5	2.5
59.3	5	60	9	61.5	5.3	62.6	5.7	63.5	5.33	64.5	2.7
59.3	5.7	60	10	61.5	7	62.8	2.3	63.5	5.5	64.5	3
59.36	3	60	11	61.5	7.5	62.87	2.03	63.5	5.7	64.5	3.2
59.4	2.8	60	12	61.6	2.4	62.87	5.33	63.5	6.35	64.5	3.5
59.4	3.1	60	13	61.6	2.62	62.9	2.4	63.5	6.5	64.5	5.5
59.44	2.01	60	14	61.6	2.7	63	1	63.5	7	64.6	2.4
59.5	2	60	15	61.6	2.9	63	1.3	63.6	4.7	64.6	3.5
59.5	3	60	16	61.6	5.7	63	1.5	63.8	5.66	64.6	5.7
59.5	5.17	60	18	61.7	4.5	63	1.8	63.8	6.2	64.7	3
59.5	6	60	20	61.8	7	63	2	63.88	5.5	64.7	5.3
59.5	6.5	60.04	1.78	61.83	2.36	63	2.4	63.9	2	64.77	1.02
59.52	2.62	60.1	1.6	61.9	3.53	63	2.5	63.9	2.4	64.77	2.49
59.6	2.4	60.1	5.7	61.94	2.24	63	2.65	64	1	64.77	2.62
59.6	5.7	60.2	2.5	62	1.5	63	2.7	64	1.4	64.9	2.6
59.7	3.53	60.2	2.8	62	1.78	63	2.8	64	1.5	64.9	6.6
59.7	5.33	60.2	3	62	2	63	3	64	1.6	65	1
59.7	5.7	60.2	5.35	62	2.5	63	3.2	64	2	65	1.5
59.7	7	60.3	5.33	62	2.6	63	3.5	64	2.5	65	1.7
59.9	2.62	60.3	15	62	3	63	3.55	64	2.6	65	1.8
59.9	5.2	60.33	3.53	62	3.2	63	4	64	2.62	65	2
59.92	3.53	60.4	3.2	62	3.5	63	4.5	64	3	65	2.5
60	1	60.5	2	62	3.53	63	5	64	3.5	65	2.65
60	1.25	60.5	2.25	62	4	63	5.3	64	3.75	65	2.75
60	1.5	60.5	5.5	62	4.5	63	5.5	64	4	65	2.8

Dichtomatik dimensions

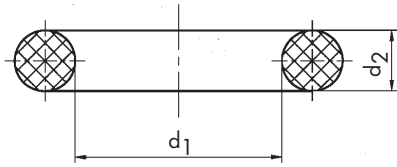

d1	d2	d1	d2	d1	d2	d1	d2
65	3	66	5	67	7.5	68.8	3.53
65	3.5	66	5.7	67	8	68.8	3.85
65	3.55	66	6	67	10	68.8	5.5
65	4	66	6.5	67	13	68.84	3.68
65	4.5	66	7	67	16	68.95	5.3
65	4.8	66	7.5	67	20	69	1.5
65	5	66	8	67.05	2.05	69	2
65	5.3	66	9	67.1	1.6	69	2.1
65	5.5	66	9.5	67.1	2	69	2.4
65	5.7	66	27	67.2	3.6	69	2.5
65	5.8	66.04	1.78	67.2	5	69	3
65	6	66.04	5.33	67.2	5.7	69	3.5
65	7	66.2	5.7	67.4	4.55	69	3.55
65	7.5	66.27	2.5	67.49	2.26	69	4
65	8	66.27	2.62	67.5	4	69	4.5
65	9	66.27	3.53	67.6	2.4	69	5
65	9.5	66.3	2.38	67.95	2.62	69	5.3
65	10	66.35	2.62	68	1	69	5.5
65	10.5	66.39	1.9	68	1.2	69	5.7
65	11	66.4	1.78	68	1.5	69	6
65	11.2	66.4	5.33	68	1.7	69	8
65	12	66.5	1	68	1.8	69	11
65	13	66.5	1.5	68	2	69.2	5.7
65	15	66.5	2	68	2.4	69.22	5.33
65.1	2.4	66.5	2.5	68	2.5	69.22	7
65.1	3.15	66.6	4.73	68	2.7	69.3	2.4
65.1	3.53	66.6	5.4	68	2.8	69.3	5.7
65.2	5	66.6	5.7	68	3	69.4	2.8
65.32	1.56	66.67	3.53	68	3.2	69.4	3.1
65.35	1.55	66.67	4.76	68	3.5	69.4	5.2
65.4	1.67	66.68	3.52	68	3.53	69.44	3.53
65.5	1.5	66.68	6.35	68	4	69.44	4
65.5	1.55	66.7	2	68	4.5	69.5	2
65.5	1.68	66.7	3.2	68	5	69.5	2.5
65.5	2	66.87	3.53	68	5.33	69.5	3
65.5	3	67	1	68	5.5	69.5	3.5
65.5	3.5	67	1.5	68	6	69.5	4
65.5	4	67	2	68	6.5	69.5	4.5
65.5	5	67	2.1	68	7	69.5	5
65.5	15	67	2.5	68	8	69.5	8
65.6	5.3	67	2.7	68	8.5	69.52	2.62
65.7	1.78	67	2.8	68	10	69.57	1.78
65.8	1.68	67	3	68	12	69.6	2
65.8	1.8	67	3.4	68	15	69.6	2.4
66	1	67	3.5	68.26	3.53	69.6	5.7
66	1.5	67	3.55	68.3	2.4	69.8	5.3
66	2	67	4	68.5	1	69.85	3.53
66	2.2	67	4.3	68.5	1.8	69.85	5.7
66	2.5	67	4.5	68.5	5.9	69.9	3.17
66	2.6	67	5	68.5	6.8	70	0.6
66	3	67	5.3	68.5	7.5	70	1
66	3.5	67	5.33	68.5	12.5	70	1.4
66	3.8	67	5.5	68.52	2.62	70	1.5
66	4	67	6	68.6	2.2	70	1.6
66	4.5	67	7	68.7	5.33	70	1.78

d1	d2	d1	d2	d1	d2	d1	d2	d1	d2	d1	d2
70	1.8	71	10	73	2	74.3	2.62	75.92	1.78	77	7
70	2	71	11	73	2.2	74.3	5.7	75.97	3.53	77	8
70	2.2	71.12	2.62	73	2.5	74.4	3.1	76	1	77	10
70	2.5	71.2	2	73	2.65	74.5	3	76	1.2	77	12
70	3	71.2	2.2	73	3	74.5	3.1	76	1.5	77.1	2.62
70	3.2	71.2	5.7	73	3.2	74.5	3.2	76	2	77.2	1.26
70	3.37	71.44	3.53	73	3.5	74.5	6	76	2.2	77.2	5.7
70	3.5	71.5	1.2	73	3.55	74.5	6.7	76	2.5	77.22	3.53
70	4	71.5	1.5	73	3.9	74.6	3	76	3	77.3	2.62
70	4.5	71.5	1.6	73	4	74.6	3.53	76	3.2	77.3	4.5
70	4.6	71.5	2	73	4.5	74.6	3.6	76	3.5	77.3	5.7
70	5	71.88	3.48	73	5	74.6	5.7	76	4	77.39	3.53
70	5.5	71.9	6	73	5.3	74.63	5.33	76	4.1	77.4	6.6
70	5.7	72	1.5	73	6	75	1	76	4.25	77.5	1.78
70	5.8	72	2	73	6.99	75	1.5	76	4.5	77.5	2.5
70	6	72	2.1	73	8	75	1.78	76	4.76	77.5	2.62
70	6.5	72	2.5	73	11	75	2	76	5	77.5	3.55
70	7	72	2.8	73	12	75	2.4	76	5.2	77.5	5.3
70	7.5	72	3	73	15	75	2.5	76	5.5	77.5	6
70	8	72	3.25	73.02	3.53	75	2.7	76	5.6	77.62	3.53
70	9.5	72	3.5	73.17	2.62	75	2.8	76	6	77.69	3.53
70	10	72	4	73.18	3	75	3	76	7.65	77.9	5.7
70	11	72	4.2	73.28	5.33	75	3.5	76	8	78	1
70	12	72	4.5	73.39	5.33	75	3.55	76	10	78	1.2
70	15	72	4.75	73.5	2	75	4	76	11	78	1.25
70	17.5	72	5	73.5	3	75	4.5	76	12	78	1.5
70.2	4.2	72	5.5	73.5	5	75	4.8	76	13	78	1.78
70.2	5.7	72	6	73.7	3.6	75	5	76	15	78	2
70.44	3	72	6.99	73.8	4.5	75	5.3	76	20	78	2.3
70.5	2.4	72	7	74	1	75	5.4	76.2	3.17	78	2.5
70.5	2.5	72	7.5	74	1.5	75	5.5	76.2	3.2	78	3
70.5	3	72	8	74	2	75	5.6	76.2	5.33	78	3.5
70.5	4.5	72	8.5	74	2.5	75	5.8	76.2	5.7	78	3.6
70.5	7.2	72	9	74	3	75	6	76.2	6.35	78	4
70.6	5.7	72	10	74	3.15	75	7	76.2	6.8	78	4.3
70.6	7	72	11	74	3.3	75	7.5	76.3	2.4	78	4.5
70.6	8	72	12	74	3.5	75	8	76.5	5.5	78	5
70.8	5.3	72	18	74	4	75	9	76.5	5.7	78	5.33
70.8	6.2	72.19	5.33	74	4.5	75	10	76.7	4.5	78	5.5
71	1.5	72.2	5.7	74	5	75	12.5	76.9	3.53	78	6
71	1.65	72.4	1.78	74	5.5	75	13	76.94	1.78	78	6.5
71	2	72.4	5.33	74	5.7	75	15	76.99	2.45	78	8
71	2.5	72.5	1.5	74	6	75	16	77	1	78	10
71	2.65	72.5	2.4	74	6.4	75.5	2	77	1.5	78	13
71	3	72.5	3.5	74	7	75.5	9.5	77	1.8	78	16
71	3.5	72.5	4	74	7.5	75.56	6.99	77	2	78.2	5.7
71	3.55	72.5	5	74	8	75.57	3.53	77	2.5	78.5	1.78
71	4	72.5	6.5	74	9	75.57	5.33	77	3	78.5	2.5
71	4.5	72.62	3.53	74	10	75.6	2	77	3.5	78.5	5
71	5	72.62	5.33	74	11	75.7	9.45	77	4	78.5	5.7
71	5.3	72.69	2.62	74	14	75.8	3.53	77	4.3	78.5	6
71	8	72.76	1.78	74.1	3.3	75.8	3.8	77	4.5	78.6	1
71	8.5	73	1	74.1	8.4	75.8	5.33	77	5	78.74	2.62
71	9	73	1.2	74.14	2.62	75.87	2.62	77	5.5	78.74	5.33
71	9.5	73	1.5	74.2	5.7	75.92	1.68	77	6	78.8	5.1

Dichtomatik dimensions

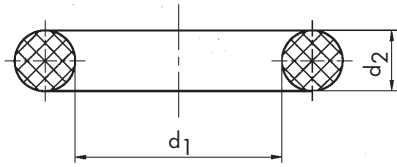

d1	d2	d1	d2	d1	d2	d1	d2
78.8	6.81	80	3	81	5.5	82.5	9
78.97	3.53	80	3.2	81	6	82.55	3.18
79	1.5	80	3.33	81	7	82.6	2.2
79	1.78	80	3.5	81	14	82.6	4
79	2	80	3.55	81.15	4.52	82.7	5.7
79	2.1	80	3.6	81.2	5.7	82.8	5
79	2.4	80	3.8	81.4	3	82.8	5.9
79	2.5	80	4	81.5	1.25	82.87	5.33
79	2.6	80	4.3	81.5	1.5	82.9	2
79	3	80	4.5	81.5	2.5	83	1
79	3.17	80	4.8	81.5	2.8	83	1.5
79	3.2	80	5	81.5	4	83	2
79	3.5	80	5.3	81.5	6	83	2.5
79	4	80	5.5	81.51	2.5	83	3
79	4.5	80	5.7	81.52	3.53	83	3.2
79	5	80	5.8	81.6	2.2	83	3.25
79	5.7	80	6	81.7	1.78	83	3.5
79	6	80	6.3	81.7	7	83	3.75
79	6.3	80	6.5	81.75	1.8	83	4
79	7	80	7	81.9	1.78	83	4.5
79	8	80	7.5	81.9	5.3	83	5
79.05	2.62	80	8	81.92	5.33	83	5.5
79.2	2.7	80	8.5	81.92	6.99	83	6
79.2	4	80	9	82	1.5	83	6.5
79.2	5.7	80	10	82	2	83	7
79.2	7.5	80	11	82	2.4	83	9
79.3	2.5	80	12	82	2.5	83	10
79.3	3.53	80	13	82	3	83	12
79.3	5.3	80	15	82	3.4	83.05	3.51
79.3	5.7	80	16.5	82	3.5	83.2	2
79.4	2	80.42	2.62	82	4	83.2	5.7
79.4	3.1	80.44	1.78	82	4.5	83.4	3.5
79.4	4.75	80.5	1.75	82	5	83.5	1.2
79.4	6.1	80.5	2	82	5.3	83.5	1.25
79.5	2	80.5	2.4	82	5.5	83.5	3
79.5	2.5	80.5	4	82	6	83.5	3.3
79.5	2.62	80.5	7	82	6.5	83.5	5
79.5	3	80.6	2.62	82	7	83.7	4.5
79.5	4	80.7	3.6	82	7.5	83.8	2.62
79.5	5.2	80.8	2.3	82	8	84	1.5
79.5	7	80.8	2.6	82	10	84	1.78
79.6	5.7	80.8	5.33	82	12	84	2
79.62	3.53	80.85	3.53	82.14	3.53	84	2.5
79.77	5.33	81	1	82.16	4.63	84	3
79.79	3.53	81	1.5	82.2	5.7	84	3.5
80	1	81	2	82.22	2.62	84	4
80	1.2	81	2.4	82.27	5.33	84	4.5
80	1.25	81	2.5	82.28	1.78	84	5
80	1.3	81	3	82.34	2.62	84	5.3
80	1.5	81	3.5	82.5	2.2	84	5.4
80	1.75	81	4	82.5	2.4	84	5.7
80	2	81	4.5	82.5	3.2	84	6
80	2.4	81	5	82.5	3.55	84	6.5
80	2.5	81	5.1	82.5	4	84	7
80	2.8	81	5.34	82.5	5.3	84	8

d1	d2	d1	d2	d1	d2	d1	d2	d1	d2	d1	d2
84	9	85	13	86.5	4.75	88	3.75	89	7.5	90	12
84	10	85	14	86.5	5	88	3.8	89	8	90	14
84	12	85	15	86.69	5.33	88	4	89	11	90	15
84.1	3.5	85	16	86.7	3	88	4.5	89	12	90	16
84.1	5.7	85.09	5.33	86.7	3.5	88	5	89	13	90	20
84.2	3	85.09	6.99	86.9	3.6	88	5.3	89.1	5.7	90	25
84.2	5.7	85.32	3.53	87	1.5	88	5.5	89.1	5.8	90.3	4
84.3	2.6	85.34	1.78	87	2	88	5.7	89.2	3	90.35	1.78
84.3	5.7	85.4	3	87	2.5	88	6	89.2	5.7	90.47	3.18
84.3	6.4	85.4	7	87	2.6	88	7.5	89.3	5.7	90.49	5.33
84.4	3.1	85.5	2.4	87	3	88	8	89.4	3.1	90.5	1.5
84.4	4	85.5	2.5	87	3.5	88	10	89.4	5.3	90.7	3.6
84.5	2	85.5	3.2	87	4	88	12	89.41	3.18	90.77	4
84.5	3	85.5	3.5	87	4.4	88	15	89.5	2.5	91	1.5
84.5	3.5	85.5	4.3	87	4.5	88	20	89.5	3	91	2
84.5	4.5	85.5	5.7	87	5	88	21	89.5	3.5	91	2.5
84.5	5	85.5	6	87	5.33	88.1	3.6	89.6	3.15	91	2.65
84.5	9.45	85.55	3.18	87	5.89	88.24	2.38	89.6	5.7	91	3
84.52	2.62	85.6	3.2	87	6	88.26	6.98	89.69	5.33	91	3.5
84.6	3	85.62	3.53	87	7	88.27	5.33	90	1	91	4
84.6	5.7	85.7	4.76	87	8	88.27	6.99	90	1.5	91	5
84.68	2.62	85.8	1.25	87	8.5	88.3	2.62	90	2	91	7
84.7	1.2	85.9	5.33	87	10	88.3	7	90	2.2	91	8
85	1	86	1.25	87	12	88.49	5.57	90	2.5	91.2	5.7
85	1.5	86	1.5	87	15	88.5	2.5	90	2.8	91.44	5.33
85	1.78	86	1.6	87	18	88.5	3.53	90	2.9	91.5	3
85	1.8	86	1.7	87	20	88.5	5.7	90	3	91.5	3.2
85	2	86	2	87.1	2.4	88.57	2.62	90	3.1	91.5	7
85	2.4	86	2.4	87.2	2.5	88.57	3.15	90	3.5	91.6	3.6
85	2.5	86	2.5	87.2	5.7	88.59	5.32	90	3.55	91.67	3.53
85	2.62	86	2.7	87.2	8	88.62	1.78	90	3.9	91.67	3.8
85	3	86	3	87.3	6.99	88.8	3	90	4	91.7	1.78
85	3.1	86	3.5	87.43	7	88.86	6.99	90	4.2	92	1.5
85	3.5	86	3.98	87.45	6.98	88.9	2.4	90	4.5	92	1.73
85	3.55	86	4	87.5	1.5	88.9	2.5	90	4.6	92	2
85	3.75	86	4.1	87.5	1.7	88.9	3.5	90	4.8	92	2.5
85	4	86	4.5	87.5	3.5	88.9	3.96	90	5	92	3
85	4.5	86	5	87.5	3.55	88.9	5.84	90	5.1	92	3.2
85	4.9	86	5.4	87.5	3.6	88.9	6.35	90	5.25	92	3.5
85	5	86	5.5	87.5	5.3	89	1.5	90	5.3	92	3.53
85	5.25	86	6	87.5	6.2	89	1.78	90	5.5	92	4
85	5.3	86	6.4	87.6	3.5	89	1.9	90	5.7	92	4.5
85	5.5	86	6.5	87.63	4.19	89	2	90	5.72	92	5
85	5.8	86	7	87.9	5.3	89	2.3	90	5.8	92	5.3
85	6	86	7.5	88	1.5	89	2.4	90	6	92	5.5
85	6.3	86	8	88	2	89	2.5	90	6.3	92	6
85	6.5	86	10	88	2.2	89	3	90	6.5	92	7
85	6.99	86	12	88	2.5	89	3.5	90	7	92	7.5
85	7	86	12.5	88	2.62	89	4	90	7.5	92	8
85	7.5	86.2	5.7	88	2.8	89	4.5	90	8	92	8.5
85	8	86.3	2.6	88	3	89	5	90	8.3	92	9
85	9	86.36	2.62	88	3.2	89	5.5	90	8.5	92	9.5
85	10	86.5	2	88	3.5	89	5.7	90	9	92	10
85	12	86.5	2.5	88	3.6	89	6	90	10	92	13
85	12.5	86.5	3	88	3.7	89	7	90	11	92	14

Dichtomatik dimensions

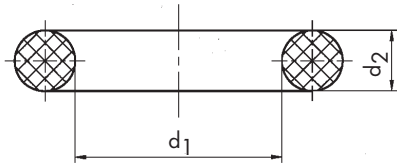

d1	d2	d1	d2	d1	d2	d1	d2
92.2	5.7	94.2	5.5	96	2.5	97.8	3.53
92.33	1.78	94.2	5.7	96	3	97.8	5.33
92.38	3.53	94.3	5.7	96	3.5	98	1
92.5	2	94.4	3.1	96	4	98	1.5
92.5	2.2	94.5	2	96	4.3	98	2
92.5	3.5	94.5	2.5	96	4.5	98	2.2
92.5	3.55	94.5	3	96	5	98	2.5
92.5	5.3	94.6	5.3	96	5.33	98	3
92.62	5.33	94.6	5.7	96	6	98	3.5
92.71	2.62	94.62	5.33	96	7	98	4
92.76	2.62	94.84	3.53	96	8	98	4.2
92.92	2.62	94.84	4.75	96	10	98	4.5
92.99	2.03	94.93	2.62	96	14	98	5
93	1.5	94.97	1.78	96	15	98	5.2
93	2	95	1	96.1	5.7	98	5.5
93	2.5	95	1.5	96.11	2.62	98	6
93	2.8	95	1.78	96.3	3.6	98	6.8
93	3	95	1.8	96.5	2.62	98	7
93	3.5	95	2	96.5	4	98	7.5
93	4	95	2.2	96.5	6.5	98	8
93	5	95	2.3	96.6	1.6	98	9
93	5.33	95	2.5	96.6	10	98	10
93	6	95	2.65	96.7	7.3	98.02	3.53
93	6.5	95	3	96.76	1.86	98.05	1.78
93	12	95	3.5	97	1	98.42	4.77
93	12.7	95	3.55	97	1.5	98.5	1.5
93	20	95	4	97	1.6	98.5	3.5
93.2	3.6	95	4.5	97	2	98.5	5.3
93.2	9.5	95	5	97	2.5	99	1.5
93.34	12.7	95	5.3	97	2.75	99	2
93.5	2	95	5.5	97	3	99	2.5
93.5	4.5	95	5.6	97	3.5	99	3
93.73	1.85	95	5.7	97	3.8	99	3.2
93.75	2	95	6	97	4	99	3.5
94	1	95	6.3	97	4.5	99	4
94	1.5	95	6.5	97	5	99	5
94	2	95	7	97	5.2	99	5.5
94	2.3	95	7.5	97	5.5	99	5.7
94	2.5	95	8	97	6	99	6
94	2.62	95	10	97	7	99	6.5
94	2.95	95	11	97	8	99	7
94	3	95	11.2	97	9	99	7.7
94	3.5	95	12	97	16	99	8
94	4	95	15	97.2	5.7	99	9
94	5	95	20	97.29	5.33	99.1	2.4
94	5.5	95.09	5.34	97.4	5.3	99.1	5.7
94	5.7	95.2	2.4	97.5	3	99.2	5.7
94	6	95.25	4.76	97.5	3.55	99.3	3
94	7	95.5	3	97.5	4.5	99.3	5.7
94	8	95.5	4	97.5	5	99.4	3.1
94	9	95.5	4.32	97.5	5.3	99.4	4.1
94	9.5	95.5	6	97.5	5.5	99.4	6.3
94	10.5	96	1.5	97.76	2.62	99.5	1.8
94.1	5.7	96	1.7	97.79	6.33	99.5	3
94.1	6	96	2	97.79	6.35	99.5	4.5

d1	d2	d1	d2	d1	d2	d1	d2	d1	d2	d1	d2
99.6	5.7	101	5.5	103	4	104.5	6	106	3.5	108	4.5
100	1	101	6	103	4.5	104.6	5.7	106	3.55	108	4.75
100	1.4	101	7	103	5	104.77	4.76	106	4	108	5
100	1.5	101	12	103	5.2	104.78	9.53	106	4.5	108	5.2
100	1.6	101.2	3.53	103	5.3	104.8	5.33	106	5	108	5.3
100	2	101.2	4.2	103	6	105	1.5	106	5.3	108	5.5
100	2.2	101.2	5.7	103	7	105	1.78	106	5.5	108	6
100	2.5	101.27	2.62	103	8	105	2	106	6	108	7
100	2.75	101.3	7.2	103	10	105	2.5	106	6.3	108	8
100	3	101.34	1.78	103	12	105	2.75	106	6.5	108	9
100	3.4	101.4	4.8	103	14	105	3	106	6.8	108	9.5
100	3.5	101.5	2	103.5	1.5	105	3.1	106	7	108	10
100	3.55	101.5	3	103.5	3	105	3.5	106	8	108	11
100	4	101.5	3.5	103.5	3.2	105	4	106	8.5	108	15
100	4.5	101.6	3.2	103.5	4	105	4.3	106	10	108	16
100	4.7	101.6	5.7	103.5	4.2	105	4.4	106	12	108	18
100	5	101.6	6.35	103.5	4.5	105	4.5	106.3	3.34	108.3	3.8
100	5.2	101.6	6.99	103.51	3.18	105	4.6	106.5	2.4	108.5	2
100	5.3	101.6	9.5	104	1.78	105	5	106.5	4.75	108.5	11.5
100	5.33	102	1.5	104	2.5	105	5.3	106.5	4.8	108.8	6
100	5.5	102	2	104	2.62	105	5.5	107	1.5	109	2
100	5.7	102	2.5	104	3	105	5.8	107	2	109	2.5
100	6	102	3	104	3.5	105	5.9	107	2.5	109	3
100	6.3	102	3.5	104	4	105	6	107	2.7	109	3.4
100	6.5	102	4	104	4.5	105	6.4	107	3	109	3.5
100	7	102	4.5	104	5	105	6.5	107	3.5	109	3.55
100	7.5	102	4.75	104	5.5	105	7	107	4	109	4
100	8	102	5	104	5.7	105	7.25	107	4.3	109	4.5
100	9.5	102	5.5	104	6	105	7.5	107	4.5	109	5
100	10	102	5.7	104	6.13	105	8	107	5	109	5.3
100	12	102	6	104	7	105	8.4	107	5.5	109	5.5
100	12.5	102	6.5	104	8	105	8.5	107	6	109	5.7
100	13.5	102	7	104	9	105	9.5	107	7	109	5.8
100	15	102	8	104	10.5	105	10	107	7.5	109	6
100	16	102	9.5	104	13	105	10.3	107	8	109	7
100	20	102	12	104	14	105	12	107	9	109	8.5
100.2	4.35	102	14	104	16	105	14	107	10	109.1	5.7
100.5	2.4	102.2	3.53	104.1	3.18	105	15	107	14	109.14	3.53
100.5	3.5	102.3	9	104.1	5.7	105	17.5	107	15	109.2	5.7
100.5	4.5	102.3	9.2	104.14	5.33	105.1	2	107.2	5.33	109.3	5.7
100.5	5.3	102.5	1.6	104.14	6.99	105.1	4.5	107.32	5.33	109.4	3.1
100.5	7	102.5	2.4	104.2	3	105.2	5.7	107.32	6.99	109.5	3
100.9	7.6	102.5	2.5	104.2	5.7	105.28	5.33	107.5	3.4	109.5	4.75
100.95	1.6	102.5	5.5	104.3	5.7	105.5	1.5	107.54	3.53	109.5	5
100.97	5.33	102.5	6.99	104.3	6	105.5	2.4	107.54	4	109.5	8.4
100.97	6.99	102.6	4.5	104.37	3.53	105.5	3	107.6	3.6	109.52	3.53
101	2	102.8	3.3	104.37	3.8	105.5	4	107.63	2.62	109.54	5.33
101	2.5	102.8	9.5	104.4	1.78	105.8	5.4	107.7	1.78	109.6	5.7
101	3	103	1.5	104.4	3.1	106	1	108	2	109.75	4.8
101	3.5	103	2	104.4	5.3	106	1.8	108	2.5	109.78	4.83
101	4	103	2.5	104.5	2	106	2	108	3	109.78	4.85
101	4.3	103	3	104.5	2.6	106	2.4	108	3.2	110	1.5
101	4.5	103	3.2	104.5	3	106	2.5	108	3.5	110	1.6
101	5	103	3.5	104.5	4	106	2.62	108	4	110	1.78
101	5.33	103	3.55	104.5	5	106	3	108	4.2	110	2

Dichtomatik dimensions

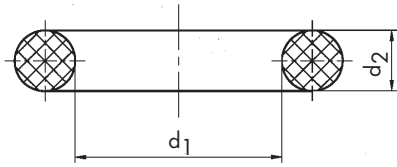

d1	d2	d1	d2	d1	d2	d1	d2
110	2.25	111.5	2.5	114	3	115	7
110	2.5	111.5	2.6	114	3.5	115	7.5
110	3	111.5	3	114	4	115	8
110	3.2	111.5	5	114	4.6	115	8.4
110	3.5	111.6	5.7	114	5	115	8.5
110	4	111.8	3.53	114	5.3	115	9
110	4.5	112	1.5	114	5.5	115	9.1
110	4.6	112	2	114	5.7	115	10
110	4.75	112	2.5	114	6	115	14
110	5	112	3	114	6.5	115	15
110	5.3	112	3.5	114	7	115	20
110	5.5	112	3.55	114	8	115.7	5.7
110	5.6	112	4	114	9	115.75	3
110	5.7	112	4.5	114	10	116	1.5
110	5.8	112	4.6	114	10.5	116	1.75
110	6	112	5	114	14	116	2
110	6.5	112	5.3	114	17	116	2.5
110	7	112	6	114.19	3.53	116	3
110	7.5	112	6.3	114.19	5.43	116	3.5
110	7.7	112	7	114.2	5.7	116	4
110	8	112	8	114.3	3.15	116	4.5
110	8.5	112	11	114.3	4.2	116	5
110	9	112	14	114.3	4.7	116	5.3
110	9.5	112.1	5.3	114.3	5.7	116	5.5
110	10	112.3	5.7	114.3	15	116	6
110	11	112.5	1.78	114.4	3.1	116	7
110	12	112.5	5	114.4	3.8	116	7.5
110	14	112.5	5.5	114.5	2.5	116	10
110	15	113	1.5	114.5	3	116	15
110	20	113	2	114.5	3.3	116.4	6.99
110.3	2.4	113	2.5	114.5	4	116.5	2
110.4	5.8	113	3	114.5	6	116.5	4.1
110.49	3.53	113	3.5	114.5	12	116.5	4.5
110.49	5.33	113	3.53	114.6	5.7	116.7	4.4
110.49	6.99	113	4	114.7	6.99	116.84	5.33
110.5	2.4	113	5	114.81	5.34	116.84	6.99
110.5	3	113	5.5	114.9	5.43	117	1.5
110.5	6	113	6	115	1.5	117	2
110.72	3.53	113.41	6.35	115	2	117	2.5
110.74	1.78	113.5	2	115	2.5	117	2.75
110.8	4	113.5	5.33	115	3	117	3
111	2	113.5	6.8	115	3.3	117	3.5
111	2.5	113.66	8.5	115	3.5	117	4
111	3	113.67	5.33	115	3.55	117	4.2
111	3.3	113.67	6.99	115	3.6	117	4.4
111	3.5	113.7	5.5	115	4	117	5
111	4	113.7	7	115	4.1	117	5.3
111	5	113.8	8.4	115	4.5	117	6
111	6	113.9	3.53	115	5	117	6.5
111	7.7	113.98	2.62	115	5.07	117	7
111	9	114	1.3	115	5.1	117	8
111.1	1.6	114	1.6	115	5.3	117	9
111.13	4.76	114	1.78	115	5.5	117	19
111.2	5.7	114	2	115	5.6	117.06	3.81
111.5	2.4	114	2.5	115	6	117.07	3.53

d1	d2	d1	d2	d1	d2	d1	d2	d1	d2	d1	d2
117.1	1.78	119.4	3.1	120.65	9.53	123	3.5	124.5	5	126	14
117.2	5.7	119.5	2	120.7	5.33	123	4	124.6	3.5	126	18
117.48	3.18	119.5	3	120.82	2.62	123	4.5	124.6	5.7	126.37	5.33
117.48	5.33	119.5	3.3	121	1.4	123	5	124.6	6.99	126.37	6.99
117.5	2.5	119.5	5.5	121	1.5	123	6	124.8	2.5	126.5	3
117.5	3.2	119.5	7	121	1.6	123	6.3	124.8	9	126.5	3.2
117.5	3.53	119.6	5.7	121	2.5	123	6.5	124.82	1.78	126.57	5.33
117.5	4	119.8	1.5	121	3	123	7	125	1.5	126.6	3.53
117.5	5	119.8	3	121	3.5	123	7.5	125	1.8	126.67	2.62
117.5	5.33	119.85	4.45	121	4	123	8	125	2	126.76	1.78
117.5	5.7	119.89	3.53	121	5	123	9	125	2.4	126.9	6.4
117.8	6.35	120	1.5	121.4	7.8	123	12	125	2.5	127	1.5
118	2	120	1.6	121.5	1.2	123	13	125	2.65	127	2
118	2.5	120	2	121.5	2	123.03	3.68	125	3	127	2.5
118	2.62	120	2.1	121.5	2.2	123.19	4.85	125	3.5	127	3
118	2.65	120	2.2	121.5	3	123.2	5.33	125	3.55	127	3.5
118	3	120	2.5	121.5	4	123.2	6.99	125	4	127	4
118	3.25	120	2.7	121.5	5.7	123.26	3.68	125	4.2	127	4.5
118	3.5	120	3	122	1	123.42	3.53	125	4.5	127	5
118	3.55	120	3.2	122	1.25	123.44	1.78	125	5	127	5.33
118	4	120	3.26	122	1.3	123.5	3	125	5.3	127	5.5
118	4.5	120	3.5	122	1.8	123.5	3.5	125	6	127	6.75
118	5	120	3.6	122	1.9	123.5	4	125	6.5	127	8
118	5.3	120	3.7	122	2	123.75	4.25	125	7	127	10
118	6	120	4	122	2.5	123.8	3.2	125	7.5	127.5	2
118	6.3	120	4.5	122	3	123.8	4.76	125	8	127.5	3
118	7	120	5	122	3.5	123.8	5.33	125	8.5	127.5	4
118	8	120	5.6	122	3.55	124	2.5	125	9.1	127.5	5.7
118	9	120	5.8	122	4	124	3	125	10	127.5	6.8
118	10	120	6	122	4.2	124	3.2	125	12	127.7	1.5
118	13	120	6.5	122	4.5	124	3.5	125	12.5	127.7	4
118.4	4	120	7	122	4.7	124	4	125	15	128	1.5
118.47	9.27	120	8	122	5	124	4.15	125.1	6.6	128	2
118.5	3	120	8.5	122	5.3	124	4.5	125.2	5.7	128	2.5
118.5	5	120	9.1	122	5.34	124	5	125.5	5	128	2.6
118.5	6.5	120	10	122	5.5	124	5.4	126	2	128	3
118.65	4.45	120	11.5	122	6	124	5.7	126	2.2	128	3.5
118.72	2.62	120	12	122	7	124	6	126	2.4	128	3.55
118.8	8.4	120	14	122	8	124	6.5	126	2.5	128	4
119	2	120	15	122	8.5	124	7	126	3	128	4.5
119	2.5	120	16	122	9	124	8	126	3.2	128	5
119	3	120	25	122	9.5	124	8.5	126	3.5	128	5.3
119	3.5	120	30	122	10	124	9	126	4	128	6
119	4	120.02	5.16	122	12	124	13	126	4.5	128	6.6
119	5	120.02	5.33	122	18	124	18	126	5	128	7
119	5.2	120.02	6.99	122	20	124.2	1.78	126	5.33	128	7.5
119	5.7	120.25	3.53	122.42	3.53	124.2	2.62	126	5.5	128	8.5
119	6	120.32	3.15	122.5	2	124.2	5.7	126	5.7	128	9
119	6.2	120.33	2.62	122.5	2.5	124.2	6.99	126	6	128	10
119	7	120.34	3.53	122.5	4	124.3	5.7	126	7	128	12
119	8	120.4	1.78	122.8	3.5	124.4	2.62	126	7.5	128.5	2.5
119	10	120.4	3.8	123	2	124.4	3.1	126	8	128.5	2.6
119.2	5.2	120.5	6.8	123	2.5	124.5	2	126	9	128.5	3.5
119.2	5.7	120.5	12	123	3	124.5	3	126	10	128.5	4
119.3	5.7	120.62	2.62	123	3.3	124.5	4	126	13	128.5	12

Dichtomatik dimensions

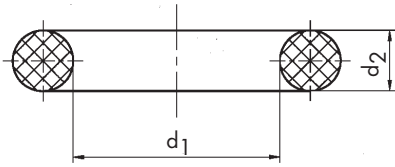

d1	d2	d1	d2	d1	d2	d1	d2
129	2	130	12	132.7	5.7	134.3	6
129	2.5	130	15	132.72	2.62	134.4	3.1
129	3	130	25	132.72	5.33	134.5	1.78
129	3.5	130.18	5.33	132.72	6.99	134.5	2
129	4	130.5	2.5	132.9	2.5	134.5	3
129	4.3	130.5	3	132.94	3.53	134.5	4
129	4.5	130.5	3.5	133	1.5	134.5	4.5
129	5	130.5	4	133	2	134.5	5
129	5.5	130.7	6	133	2.5	134.5	6.99
129	8	130.85	7	133	2.62	134.6	5.7
129	10	131	1.7	133	3	135	1.5
129	11	131	2.4	133	3.2	135	1.9
129.04	5.33	131	2.5	133	3.25	135	2
129.1	3.3	131	3	133	3.5	135	2.2
129.14	3.1	131	3.5	133	4	135	2.5
129.2	5.7	131	4	133	4.4	135	2.65
129.3	5.4	131	4.5	133	4.5	135	2.75
129.3	5.7	131	5	133	5	135	3
129.4	1.78	131	5.3	133	6	135	3.1
129.4	3.1	131	7	133	7	135	3.2
129.5	3	131	10	133	8	135	3.38
129.5	5	131.2	2.4	133	10	135	3.5
129.5	5.33	131.2	5.7	133	12	135	4
129.54	1.65	131.3	5.7	133	13	135	4.1
129.54	5.33	131.5	3.55	133	16	135	4.5
129.54	6.99	131.5	4	133.07	1.78	135	5
129.6	5.7	131.5	4.5	133.2	5.7	135	5.5
129.77	3.53	131.57	1.78	133.3	6.4	135	5.7
129.77	3.8	131.6	5.7	133.35	3.17	135	5.8
130	1.5	131.74	1.78	133.35	5.33	135	6
130	2	131.8	1.78	133.35	12.7	135	6.5
130	2.4	132	1.5	133.5	4	135	7
130	2.5	132	1.7	133.5	7	135	7.5
130	3	132	1.8	133.6	2.2	135	7.7
130	3.15	132	2	133.8	8.4	135	8
130	3.5	132	2.4	134	1.5	135	9
130	4	132	2.5	134	1.6	135	9.1
130	4.2	132	3	134	2	135	10
130	4.3	132	3.5	134	2.5	135	11
130	4.5	132	3.55	134	3	135	12
130	5	132	3.9	134	3.1	135	13
130	5.5	132	4	134	3.2	135	15
130	5.8	132	4.5	134	3.5	135	17
130	6	132	5	134	4	135	17.5
130	6.35	132	5.3	134	4.2	135	18
130	6.5	132	5.65	134	4.5	135.4	4.2
130	6.65	132	6	134	5	135.5	4
130	7	132	7	134	6	135.5	9.2
130	7.5	132	8	134	6.8	135.6	4.12
130	8	132	10	134	8	135.7	3.53
130	9	132.2	2.3	134	11	135.76	1.78
130	9.6	132.2	5.7	134.1	8.4	135.9	5.33
130	10	132.4	2.62	134.2	4	135.9	6.99
130	10.8	132.5	1.6	134.2	5.7	136	2.5
130	11	132.5	2.4	134.3	5.7	136	3

d1	d2	d1	d2	d1	d2	d1	d2	d1	d2	d1	d2
136	3.5	139	3.5	140	10	143	4	145	8.6	148	4.5
136	3.55	139	4	140	11	143	5	145	10	148	5
136	4	139	4.5	140	12	143	5.7	145	15	148	5.5
136	4.25	139	5	140	15	143	6	145.29	1.78	148	6
136	5	139	6	140	16	143	6.35	145.41	3.3	148	7
136	5.3	139	7	140.37	3.53	143	6.5	145.42	5.16	148	8
136	6	139.07	1.78	140.5	4.5	143	8	145.42	5.33	148	10
136	7	139.07	5.33	140.64	5.34	143	10	145.42	6.99	148	12
136	8	139.07	6.99	141	2.4	143	12	145.42	7.92	148.2	5.7
136	10	139.2	2.4	141	2.5	143.4	3	145.45	6.55	148.46	1.78
136	12	139.2	2.8	141	3	143.5	1.6	145.5	6.35	148.5	2
136	13	139.2	5	141	3.5	143.5	1.78	145.5	6.5	148.5	4
136	17	139.2	5.7	141	4	144	2.5	145.65	3.53	148.5	5
136.12	3.53	139.2	6	141	4.5	144	3	145.72	2.62	148.5	7.5
136.5	4	139.3	2.4	141	5	144	3.5	145.77	1.78	148.5	8.4
136.5	4.5	139.3	3.53	141	6.25	144	3.7	146	2	148.59	5.33
136.5	6	139.3	5.7	141	7	144	3.8	146	2.5	148.6	5.33
136.53	5.33	139.38	2.62	141	9.8	144	4	146	3	148.6	6.99
137	2.5	139.4	3.1	141.5	2.5	144	4.5	146	3.5	148.82	3.53
137	2.62	139.5	3	141.5	3	144	5	146	4	149	2.5
137	3	139.5	4.5	141.5	7	144	5.25	146	4.5	149	3
137	3.4	139.6	5.7	141.5	10	144	5.5	146	4.57	149	3.5
137	3.5	139.7	4.75	141.5	12	144	6	146	5	149	4
137	4	139.7	5.33	142	2	144	6.5	146	5.5	149	5
137	4.5	139.7	6.99	142	2.5	144	8	146	6	149	6
137	4.7	139.7	7.92	142	3	144	10	146	7	149	6.5
137	5	139.7	15	142	3.5	144	10.7	146	8	149	7
137	6	140	1.5	142	4	144.02	1.78	146	12	149	8
137	6.5	140	1.78	142	5	144.1	8.4	146.05	5.33	149	12
137	7	140	2	142	5.33	144.2	3	146.07	4.7	149.1	8.4
137	8	140	2.3	142	6	144.2	5.7	146.1	3.2	149.2	4.76
137.37	2.62	140	2.4	142	6.3	144.27	4.06	146.3	5.7	149.2	5.7
137.5	2.5	140	2.5	142	6.5	144.3	5.7	146.5	4	149.2	6.2
137.5	3	140	2.65	142	7	144.4	3.1	147	1.78	149.23	5.33
137.8	20	140	3	142	7.5	144.5	3	147	2.5	149.3	5.7
138	2	140	3.15	142	8	144.5	3.7	147	3	149.5	2
138	2.1	140	3.2	142	10	144.5	4	147	3.5	149.5	3
138	2.5	140	3.5	142	12	144.6	5.7	147	4	149.5	8.4
138	3	140	3.55	142	18	144.7	3	147	4.33	149.5	9.5
138	3.5	140	3.75	142.11	1.78	145	1.5	147	5	149.6	5.7
138	4	140	3.8	142.24	5.33	145	2.5	147	6.5	150	1.2
138	4.4	140	4	142.24	6.99	145	3	147	8	150	2
138	4.5	140	4.3	142.47	3.53	145	3.5	147	14	150	2.38
138	5	140	4.5	142.5	3	145	3.55	147	15	150	2.5
138	5.3	140	5	142.5	5	145	4	147.3	3	150	2.62
138	6	140	5.3	142.7	5.7	145	4.2	147.5	3	150	3
138	6.5	140	5.5	142.8	5.8	145	5	147.5	4.5	150	3.1
138	7	140	5.8	142.88	5.33	145	5.25	147.55	2.62	150	3.5
138	8	140	6	143	1.78	145	5.3	148	1.78	150	3.55
138	10	140	6.3	143	2	145	5.5	148	2	150	4
138	16	140	6.35	143	2.5	145	6	148	2.5	150	4.5
138.5	6.55	140	7	143	3	145	6.5	148	3	150	5
138.94	1.78	140	7.5	143	3.5	145	7	148	3.5	150	5.3
139	2.5	140	8	143	3.7	145	7.5	148	3.75	150	5.4
139	3	140	8.6	143	3.97	145	8	148	4	150	5.5

Dichtomatik dimensions

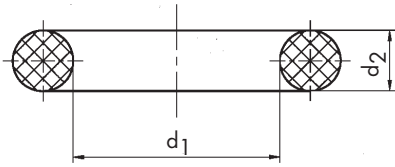

d1	d2	d1	d2	d1	d2	d1	d2
150	5.8	152.2	5.5	155	4.5	158	2
150	6	152.5	1.5	155	5	158	2.5
150	6.35	152.5	2.5	155	5.3	158	3
150	6.5	152.5	7	155	5.33	158	3.5
150	6.7	152.62	2.62	155	5.5	158	4
150	7	153	2	155	5.7	158	4.5
150	7.5	153	2.5	155	6	158	5
150	8	153	3	155	6.75	158	6
150	9	153	3.5	155	7	158	6.5
150	10	153	4	155	7.5	158	6.7
150	11	153	4.5	155	8	158	6.9
150	12	153	5	155	9	158	7
150	15	153	6	155	9.5	158	8
150	20	153	10	155	10	158	12
150.88	3.53	153	14	155	15	158	16
151	2.6	153	15	155.5	6	158	18
151	3	153.5	1.6	155.5	7	158.12	2.62
151	3.5	153.5	3	155.6	5.33	158.12	5.33
151	4	153.5	5	155.6	6.99	158.12	6.99
151	5	153.5	6.8	156	2	158.35	3.53
151	7	153.52	6.99	156	2.5	158.4	3.2
151	8	154	3	156	3	158.41	2.62
151.4	4	154	3.5	156	3.5	158.44	3.53
151.5	2.5	154	4	156	4	158.59	5.33
151.5	8.5	154	5	156	4.8	158.75	6.35
151.59	1.78	154	6	156	5	158.75	12.7
151.64	1.78	154	7	156	5.5	158.8	6.4
151.69	3.2	154	8	156	6	158.88	2.62
151.77	3	154	10	156	6.5	159	2.5
151.77	5.33	154	12	156	7	159	3
151.77	6.99	154.1	8.4	156	8	159	3.5
151.78	1	154.2	5.33	156	10	159	4
151.8	4	154.2	5.7	156	12	159	5
151.99	2.4	154.3	5.7	156	16	159	6
151.99	3.53	154.3	6.4	156.3	5.7	159	6.3
152	1.5	154.4	3.1	156.5	2.5	159	6.8
152	1.6	154.4	4	156.5	5.7	159	7
152	2	154.5	3	156.5	7	159	11
152	2.5	154.5	4	157	1.5	159.1	8.4
152	2.6	154.5	5	157	2	159.2	5.7
152	3	154.5	8.4	157	3	159.2	7
152	3.5	154.5	10	157	3.5	159.3	2.4
152	4	154.81	1.78	157	4	159.3	5.7
152	5	155	1.5	157	4.5	159.5	2.5
152	5.1	155	1.7	157	5	159.5	3
152	5.5	155	2	157	6	159.5	6.99
152	6	155	2.5	157	6.5	159.5	8.4
152	7	155	2.6	157	6.55	159.5	9.5
152	7.5	155	3	157	7.5	159.7	3
152	8	155	3.1	157	8	160	1.5
152	8.5	155	3.2	157	8.3	160	2
152	10	155	3.5	157	15	160	2.3
152	12	155	3.55	157	20	160	2.4
152.07	2.62	155	4	157.5	7	160	2.5
152.09	5.12	155	4.2	158	1.78	160	3

d1	d2	d1	d2	d1	d2	d1	d2	d1	d2	d1	d2
160	3.5	162.5	2.5	164.78	2.62	167.4	3.3	170	5.5	172.5	3.5
160	3.55	162.5	3.5	165	1.5	167.5	2.62	170	5.8	173	2
160	4	162.5	4	165	2	167.5	3.5	170	6	173	2.4
160	4.2	162.6	7	165	2.4	167.5	5.7	170	6.4	173	2.5
160	4.5	162.76	2.38	165	2.5	167.5	8	170	6.5	173	3
160	4.75	163	1.5	165	3	167.51	1.78	170	7	173	3.1
160	5	163	1.78	165	3.5	167.7	5.33	170	7.5	173	3.5
160	5.25	163	2	165	3.55	167.8	2.62	170	8	173	3.6
160	5.3	163	3	165	4	168	2	170	8.5	173	4
160	5.5	163	3.5	165	4.5	168	3	170	9	173	5
160	5.8	163	4	165	5	168	3.5	170	9.5	173	5.33
160	6	163	4.5	165	5.3	168	4	170	10	173	8
160	7	163	5	165	5.5	168	4.5	170	12	173	9
160	7.2	163	6	165	6	168	5	170	12.5	173	10
160	7.5	163	6.35	165	6.2	168	6	170	13	173.37	5.7
160	8	163	7	165	6.5	168	7	170	14	173.5	3
160	8.5	163	9	165	7	168	8	170	15	173.5	5
160	9	163.1	2.5	165	7.5	168	10	170.3	4.7	173.87	1.78
160	10	163.3	2.5	165	8	168	11	170.39	3.53	174	2.5
160	12	163.6	2.2	165	10	168	12	170.4	4	174	2.62
160	14	163.7	8.6	165	12	168	16	170.69	1.78	174	3
160	14.3	163.8	7	165	14	168.3	5.7	170.82	5.33	174	3.2
160	15	164	2	165	16	168.3	6.99	170.82	5.83	174	3.3
160	16	164	3	165	20	168.5	3	170.82	6.99	174	3.5
160	20	164	3.5	165.4	5.33	168.5	6.25	171	2.7	174	4
160.3	2.5	164	4	165.5	4	169	2.4	171	3	174	5
161	2.4	164	4.1	165.5	5.5	169	2.5	171	3.5	174	5.25
161	3	164	4.7	166	1.78	169	3	171	3.53	174	5.33
161	3.5	164	5	166	2.5	169	3.5	171	4	174	6
161	4	164	6	166	3	169	4	171	5	174.1	8.4
161	5	164	7	166	3.5	169	5	171	7	174.2	3.6
161	10	164	7.2	166	4	169	6	171	9	174.2	5.7
161.1	10	164	8	166	5	169	15	171	10	174.3	5.33
161.16	1.78	164	8.3	166	6	169.1	8.4	171	11	174.3	5.7
161.3	5.33	164	8.4	166	6.2	169.2	5.7	171	12	174.4	3.2
161.3	10	164	8.5	166	10	169.2	6.2	171.05	3.53	174.5	3
161.6	2.4	164	10	166	13	169.2	7	171.13	2.62	174.5	8.4
161.9	6.99	164	12	166	15	169.3	5.7	171.4	3.2	174.6	6.99
162	2.3	164	12.7	166	19	169.5	3	171.45	6.35	175	2
162	2.5	164.1	8.4	166.1	2.5	169.5	8.4	172	1.78	175	2.4
162	3	164.2	5.7	166.2	14	170	1.78	172	2	175	2.5
162	3.15	164.2	6.99	166.2	20	170	2	172	2.5	175	2.62
162	3.5	164.3	3	166.7	6.99	170	2.4	172	3	175	2.7
162	3.53	164.3	5.7	166.75	2	170	2.48	172	3.5	175	3
162	4	164.34	1.78	166.8	5.3	170	2.5	172	4	175	3.5
162	4.5	164.47	5.33	167	2.5	170	2.62	172	4.2	175	3.55
162	5	164.47	6.99	167	3	170	3	172	4.5	175	4
162	6	164.5	2	167	3.5	170	3.1	172	4.8	175	4.5
162	7	164.5	3	167	4	170	3.2	172	5	175	5
162	8	164.5	3.53	167	5	170	3.5	172	5.5	175	5.2
162	10	164.5	7	167	6.5	170	3.55	172	6	175	5.3
162	12	164.5	8.4	167	7	170	4	172	6.3	175	5.5
162.1	5.2	164.5	13	167	8	170	4.5	172	7	175	6
162.3	2.5	164.67	5.33	167	10	170	5	172	8	175	7
162.3	6.35	164.7	3.53	167.28	8	170	5.3	172.5	2.5	175	7.5

Dichtomatik dimensions

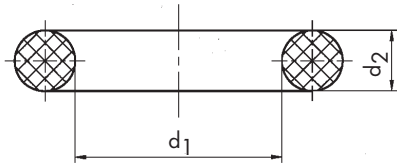

d1	d2	d1	d2	d1	d2	d1	d2
175	8	178	10	181	4	184.15	6.35
175	10	178	12	181	5	184.2	5.7
175	12	178	15	181	6.99	184.3	5.7
175	13	178	20	181	7	184.5	3
175	15	179	2.5	181.4	4.3	184.5	8.4
175.13	5.33	179	3	181.48	5.33	185	1.5
175.3	2.4	179	3.2	181.5	2.5	185	2
175.5	3	179	3.5	181.5	16	185	2.5
175.6	14	179	4	181.8	2.4	185	2.62
175.6	20	179	5	182	1.78	185	3
176	2.4	179	5.5	182	2	185	3.1
176	2.5	179	8	182	3	185	3.2
176	2.7	179	10	182	3.5	185	3.25
176	3	179	12	182	4	185	3.5
176	3.5	179.1	8.4	182	5	185	3.55
176	3.6	179.2	5.7	182	6	185	4
176	4	179.3	5.7	182	7	185	4.2
176	5	179.4	3.1	182	8	185	4.5
176	6	179.5	2	182	8.3	185	5
176	7	179.5	3	182.3	7	185	5.3
176.2	7	179.5	5	182.5	4	185	6
176.26	2.38	179.5	8.4	183	3	185	6.5
176.8	3.53	180	1.5	183	3.5	185	7
176.8	3.6	180	2	183	4	185	7.5
177	1.5	180	3	183	5	185	8
177	1.78	180	3.1	183	6	185	8.5
177	2	180	3.5	183	7	185	9
177	2.62	180	3.55	183	9	185	10
177	3	180	4	183	10	185	15
177	3.5	180	4.2	183.33	2.62	185.34	3.5
177	4	180	4.5	183.5	3	185.4	5.33
177	4.4	180	4.76	183.52	5.33	185.5	8.5
177	5	180	5	183.52	6.99	186	3
177	7	180	5.3	183.74	5.33	186	3.5
177.17	5.33	180	5.4	183.75	3.53	186	4
177.17	6.99	180	5.5	183.83	2.62	186	4.5
177.4	3.53	180	5.7	184	1.5	186	5
177.4	5	180	5.8	184	1.78	186	6
177.4	5.5	180	6	184	2	186	7
177.47	2.62	180	7	184	2.5	186	8
177.5	4.2	180	7.5	184	3	186	9.5
177.5	10	180	8	184	3.5	186.5	3.53
177.5	12	180	9	184	4	186.5	8.5
177.8	6.35	180	10	184	5	187	3
177.8	6.6	180	10.2	184	5.7	187	3.5
177.9	8	180	14	184	6	187	3.53
178	2	180	15	184	6.4	187	4
178	3	180	16	184	6.5	187	5
178	3.5	180	17	184	7	187	5.33
178	4	180	20	184	8	187	7
178	4.5	180.34	1.78	184	8.4	187.3	6.99
178	5	180.37	2.39	184	10	187.5	4
178	6	181	2	184	12.7	187.5	6
178	7	181	3	184	15	187.5	15
178	8	181	3.5	184.1	8.4	187.62	2.62

d1	d2	d1	d2	d1	d2	d1	d2	d1	d2	d1	d2
187.7	1.7	190	6	193.5	5	196.22	6.99	200	5.3	204	2.5
187.74	3.53	190	6.3	193.5	5.33	196.22	8	200	5.5	204	3
188	1.5	190	6.5	193.7	6.99	196.44	3.53	200	5.6	204	3.5
188	2	190	7	194	2	196.44	6.35	200	6	204	4
188	3	190	7.5	194	2.2	196.53	2.62	200	6.3	204	4.5
188	3.5	190	8	194	2.5	196.9	3.2	200	6.5	204	5
188	4	190	8.5	194	3	197	3	200	7	204	6
188	5	190	9	194	3.5	197	3.5	200	8	204	7
188	6	190	10	194	4	197	4	200	8.35	204	8
188	6.5	190	12	194	5	197	5	200	8.6	204	8.4
188	7	190	13	194	5.33	197	8	200	10	204	15
188	8	190	14	194	6.1	197.15	3.53	200	10.2	204.1	8.4
188	10	190	15	194	7	198	3	200	11	204.2	5.2
188	12	190	20	194.1	8	198	3.5	200	12	204.2	5.7
188	15	190	25	194.1	8.4	198	3.8	200	15	204.4	14
188.1	2.5	190.1	3.53	194.2	5.7	198	4	200.5	8.4	204.5	3
188.5	9	190.18	2.62	194.3	3.1	198	5	200.7	6.99	204.5	8.4
189	2.6	190.5	3.17	194.3	5.7	198	6	201	3	204.7	3.5
189	3	191	3	194.44	2.53	198	6.5	201	3.5	205	1.5
189	3.5	191	3.5	194.5	2	198	7	201	4	205	2
189	4	191	4	194.5	3	198	7.5	201	5	205	2.5
189	4.5	191	5	194.5	8.4	198	8	201	6	205	3
189	5	191	5.5	194.7	5.3	198	9.5	201	8	205	3.5
189	6	191	6	195	2	198	10	201	9	205	3.6
189	8.4	191	7	195	2.5	198.5	3	201	10	205	4
189.1	8.4	191	7.5	195	3	198.7	10	201	11	205	4.5
189.2	5.7	191	8	195	3.5	199	3	201	12	205	5
189.3	5.33	191	14	195	3.55	199	3.5	202	2	205	5.33
189.3	5.5	191.1	6	195	3.75	199	4	202	3	205	5.5
189.3	5.7	191.2	6	195	4	199	5	202	3.5	205	6
189.5	2.5	192	2	195	5	199	7	202	3.6	205	7
189.5	3	192	2.5	195	5.3	199	11	202	4	205	7.5
189.5	4.5	192	3	195	5.5	199.1	8.4	202	5	205	8
189.5	8.4	192	3.5	195	5.9	199.2	5.7	202	5.5	205	9
189.6	5	192	4	195	6	199.2	7	202	6	205	11
189.8	2.5	192	4.5	195	7	199.3	3	202	7	205	15
189.86	7.06	192	5	195	7.5	199.3	5.7	202	8	205	20
189.87	5.33	192	6	195	8	199.5	3	202	12.5	205.3	6
189.87	6.99	192	6.1	195	8.6	199.5	8.4	202	12.7	205.87	11.1
190	2	192	7	195	9	199.8	6.99	202	18	206	3
190	2.5	192	8	195	10	200	1.5	202.57	5.33	206	3.5
190	2.6	192	14	195	15	200	1.6	202.57	6.99	206	4
190	2.65	192.22	6.99	195	16	200	1.78	202.79	3.53	206	5
190	2.7	193	1.5	195.5	5	200	2	202.87	2.62	206	5.3
190	3	193	2	196	3	200	2.5	203	3	206	5.7
190	3.1	193	2.62	196	3.5	200	2.62	203	3.5	206	6.99
190	3.2	193	3	196	4	200	2.8	203	4	206	7
190	3.5	193	3.5	196	4.5	200	3	203	5	206	8
190	3.55	193	4	196	5	200	3.2	203	6	206	10
190	4	193	5	196	6	200	3.5	203	6.35	206	12
190	4.5	193	6	196	7	200	3.55	203	7	206	14
190	5	193	6.5	196	8	200	4	203	12	206	15
190	5.3	193	7	196	10	200	4.2	203	15	206.5	3.53
190	5.5	193	16	196.22	1.78	200	4.5	203.5	4	207	3
190	5.8	193.5	4	196.22	5.33	200	5	203.5	6	207	3.5

Dichtomatik dimensions

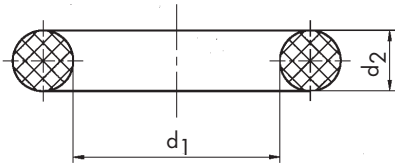

d1	d2	d1	d2	d1	d2	d1	d2
207	4	210	6.5	214	5.5	217	5
207	4.5	210	7	214	6	217	5.2
207	5	210	7.5	214	7	217	6
207	5.7	210	8	214	12	217	7
207	7	210	8.6	214	20	217	7.5
207	9	210	9.5	214.1	8.4	217	8
207.5	5.5	210	10	214.3	5.7	217.5	2.5
207.5	7.5	210	11	214.5	3	218	2
208	3	210	12	214.5	7	218	2.2
208	3.3	210	13	214.5	8.4	218	3
208	3.5	210	20	215	2.2	218	3.5
208	3.6	211	3	215	2.5	218	3.55
208	4	211	3.5	215	3	218	3.6
208	4.5	211	4	215	3.5	218	4
208	5	211	5	215	4	218	4.2
208	5.5	211	5.7	215	4.5	218	4.5
208	6	211	12	215	5	218	5
208	6.65	211.5	5.7	215	5.3	218	5.3
208	7	212	1.78	215	5.5	218	5.33
208	8	212	2.5	215	5.7	218	5.8
208	8.5	212	2.75	215	6	218	6
208	9	212	3	215	6.4	218	6.35
208.5	3.5	212	3.15	215	6.5	218	7
208.5	8.4	212	3.5	215	7	218	7.2
208.92	5.33	212	3.55	215	7.5	218	8
208.92	6.99	212	4	215	8	218	10
209	1.78	212	5	215	10	218	12
209	3	212	5.3	215	13.5	218	19
209	3.5	212	5.7	215	20	218.19	3.53
209	4	212	6	215.17	2.62	218.4	4.18
209	5	212	6.3	215.27	2.62	218.5	4.5
209	5.3	212	6.5	215.27	5.33	218.5	5.8
209	7	212	7	215.27	6.99	218.7	2
209.1	8.4	212	8	215.49	1.78	219	3
209.14	3.53	212	10	215.49	3.53	219	3.4
209.2	5.7	212	12	215.58	2.62	219	3.5
209.23	2.62	212.4	7.3	215.65	1.59	219	4
209.3	5.7	212.5	4.5	215.67	5.33	219	4.5
209.5	3	212.5	15	215.9	1.78	219	5
209.5	6	212.6	2.18	215.9	6.35	219	8.4
209.5	8.4	213	2.4	216	2	219	16
209.55	6.35	213	3	216	3	219.1	8.4
210	1.5	213	3.5	216	3.5	219.2	5.7
210	1.8	213	4	216	4	219.3	5.7
210	2	213	5	216	5	219.49	3.53
210	2.5	213	5.4	216	6	219.5	3
210	3	213	8.5	216	6.99	219.5	5.33
210	3.1	213.91	6.35	216	8	219.5	8.4
210	3.5	214	2	216.5	2.5	220	2
210	4	214	2.5	216.65	1.9	220	3
210	4.5	214	3	216.65	2.7	220	3.5
210	5	214	3.5	217	1.78	220	4
210	5.5	214	4	217	3	220	4.5
210	6	214	4.5	217	3.5	220	5
210	6.4	214	5	217	4	220	5.33

d1	d2	d1	d2	d1	d2	d1	d2	d1	d2	d1	d2
220	5.7	223.3	5.7	227	4	230	6	234.3	5.7	238	3.5
220	6	223.9	8.2	227	4.5	230	7	234.32	5.33	238	3.6
220	6.5	224	3	227	5	230	7.5	234.32	6.99	238	4
220	6.8	224	3.5	227	6.5	230	8	234.5	3.3	238	5
220	7	224	3.55	227	7	230	8.72	234.5	5.33	238	5.5
220	7.5	224	3.8	227	9	230	9	234.5	8.4	238	5.7
220	8	224	4	227	10	230	10	234.54	3.53	238	6
220	8.2	224	5	227	20	230	11	234.63	2.62	238	6.3
220	8.4	224	5.3	227.97	5.33	230	15	234.82	2.62	238	7
220	8.6	224	6.3	227.97	6.99	230	18	235	2	238	8
220	10	224	7	228	2.5	230	20	235	2.3	238	10
220	10.11	224	8.4	228	2.6	230.84	3.5	235	2.5	238	12
220	14	224	10	228	3	231	3	235	3	239	3
220	15	224.2	2.5	228	3.5	231	3.5	235	3.5	239	3.5
220	16	224.3	3.1	228	4	231	4	235	4	239	4
220	20	224.5	6.4	228	5	231	5	235	5	239	5
221	3	224.5	8.4	228	5.7	231	8.4	235	5.33	239	6
221	3.5	225	2	228	6	231	15	235	5.5	239	6.5
221	4	225	2.5	228	7	231.78	11.11	235	6	239	7
221	4.5	225	2.8	228	7.5	232	2.5	235	6.99	239	7.5
221	5	225	3	228	8	232	3	235	7	239	8
221	6	225	3.5	228	10	232	3.5	235	8	239	10
221	8	225	3.53	228	20	232	4	235	8.5	239.1	8
221.5	5.7	225	4	228.19	3.53	232	5	235	9	239.1	8.4
221.62	5.33	225	4.5	228.28	2.62	232	6	235	10	239.1	10
221.62	6.99	225	5	228.47	7.66	232	7	235	12	239.2	5.7
221.84	3.53	225	5.2	228.6	6.35	232	8	235	15	239.3	5.7
221.93	2.62	225	5.7	228.8	2.5	232	9.5	235	15.9	239.3	6.5
222	1.78	225	6	229	3	232	9.52	236	3	239.3	7
222	2	225	6.3	229	3.5	232	17	236	3.5	239.5	2.75
222	2.5	225	6.5	229	4	232.2	3.6	236	3.55	239.5	3
222	2.62	225	7	229	5	232.55	3.53	236	4	239.5	7.5
222	3	225	8	229	6	233	3	236	5	239.5	8.4
222	3.2	225	10	229	9	233	3.2	236	5.3	240	2
222	3.5	225	12	229	12	233	3.5	236	6	240	2.5
222	4	225	15	229.1	8.4	233	4	236	7	240	3
222	5	225	20	229.2	5.7	233	5	236	12	240	3.5
222	5.5	225.2	5.7	229.3	5.7	233	6.5	236	14	240	3.53
222	6	225.5	5	229.5	3	233	7	236.55	4.33	240	4
222	6.5	226	2	229.5	5	233	8	237	3	240	4.2
222	6.53	226	2.5	229.5	8.4	234	2.5	237	3.15	240	4.5
222	7	226	3	230	1.78	234	3	237	3.5	240	4.8
222	12	226	3.5	230	2	234	3.5	237	3.53	240	5
222	12.7	226	4	230	2.5	234	4	237	4	240	5.7
222.4	5	226	5	230	3	234	5	237	4.2	240	6
222.5	3	226	6	230	3.5	234	6	237	5	240	6.5
222.5	6	226	8	230	3.55	234	6.5	237	5.5	240	7
222.94	2.6	226	10	230	3.8	234	8	237	6	240	7.5
223	2	226	11	230	4	234	8.4	237	7	240	8
223	3	226	12.7	230	4.5	234	8.5	237	7.5	240	8.4
223	3.5	227	2	230	5	234	10	237.2	2.2	240	8.6
223	4	227	2.5	230	5.3	234	15	237.5	6	240	9
223	5	227	3	230	5.33	234	16	238	2	240	10
223	6	227	3.3	230	5.5	234.1	8.4	238	3	240	11
223	12	227	3.5	230	5.7	234.22	5.33	238	3.2	240	12

Dichtomatik dimensions

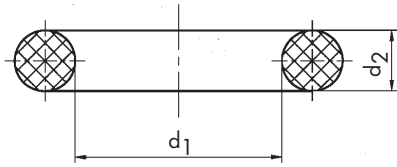

d1	d2	d1	d2	d1	d2	d1	d2
240	14	245	2	248	11	251.14	6.99
240	15	245	2.5	248	12	251.3	7
240	20	245	2.62	248	13	252	2
240.1	3.9	245	3	248	15	252	2.5
240.67	5.33	245	3.5	248.2	7.2	252	3.5
240.67	6.99	245	4	248.5	7	252	3.53
240.89	3.53	245	5	249	3	252	3.6
240.98	2.62	245	5.34	249	3.5	252	4
241	2.5	245	6	249	4	252	5
241	3	245	6.5	249	5	252	5.7
241	3.5	245	6.7	249	6	252	6
241	4	245	7	249	7	252	10
241	5	245	7.5	249	8	252	15
241	5.3	245	8	249	8.4	252.8	3.6
241	6	245	10	249.1	8.4	253	3.5
241	6.4	245	11	249.1	8.5	253	4
241	7	245	12	249.2	5.7	253	5
242	3	245	15	249.3	5.7	253	5.34
242	3.5	245.2	5.7	249.5	3	253	7
242	4	246	2	249.5	8.4	253	8
242	4.5	246	2.5	250	2	253	12
242	5	246	3	250	2.5	253.3	6.99
242	6	246	3.5	250	2.62	253.37	5.33
242	6.5	246	4	250	3	253.4	7
242	8	246	5	250	3.5	253.5	3.53
242.02	5.33	246	6	250	3.53	253.57	5.33
242.5	8	246	8	250	3.55	253.57	6.99
242.5	10	246	9.5	250	4	253.59	1.78
242.6	6	246	15	250	4.5	253.59	3.53
243	2.93	247	2	250	4.6	253.77	7
243	3	247	3	250	5	253.8	14
243	3.3	247	3.5	250	5.3	253.97	6.99
243	3.5	247	4	250	5.33	254	3
243	4	247	5	250	5.5	254	3.5
243	4.5	247	5.33	250	5.7	254	4
243	5	247	6	250	6	254	5
243	7	247	6.99	250	6.3	254	6.35
243	8.5	247	7	250	6.5	254	8
243	17	247	8	250	7	254	10
243.5	1.78	247	10	250	8	254.1	1.9
243.5	6	247	12	250	9	254.3	5.7
244	2	247.02	5.33	250	10	254.5	3
244	3	247.24	3.53	250	12	254.5	4.52
244	3.5	247.33	2.62	250	15	254.5	8.4
244	4	248	2	250	18	254.7	8
244	5	248	3	250	20	255	2
244	5.5	248	3.2	250.5	9.5	255	2.5
244	6	248	3.5	250.9	9.1	255	3
244	7	248	4	251	3	255	3.5
244	8	248	5	251	3.5	255	3.53
244	9	248	6	251	4	255	4
244	11	248	7	251	5	255	4.2
244.1	8.4	248	8	251	7	255	5
244.3	5.7	248	9	251	8	255	5.7
244.5	8.4	248	10	251	12	255	6

d1	d2	d1	d2	d1	d2	d1	d2	d1	d2	d1	d2
255	7	259.5	8.4	264	4.6	267	6	270	14	275	13
255	8	259.7	6.99	264	4.8	267	6.5	271	3	275	14
255	10	260	2	264	5	267	7	271	3.5	275.6	3.53
255	20	260	2.5	264	8	267	14	271	4	275.8	8
255.5	10.2	260	3	264	8.2	267.5	5.5	271	5	276	2
256	2	260	3.5	264	8.4	268	2.5	271	5.33	276	2.15
256	2.5	260	3.53	264	18	268	3	272	2.5	276	3
256	3.5	260	4	264.1	8.4	268	3.5	272	3	276	3.5
256	4	260	4.1	264.2	5.7	268	4	272	3.5	276	4
256	5	260	4.5	264.5	2.62	268	5	272	3.53	276	5
256	7.2	260	5	264.5	8.4	268	6.8	272	4	276	5.34
256	7.3	260	5.5	264.8	6.6	268	7	272	4.3	276	6
256	7.5	260	6	265	2	268	8	272	5	276	6.4
256	8	260	6.5	265	2.5	268	8.4	272	5.3	276	7
256	10	260	6.99	265	3	268	10	272	7	276	8
256	12	260	7	265	3.2	268.5	8.4	272.4	6.99	276	12
256.5	8.5	260	8	265	3.5	268.8	8.4	272.4	7	276.43	2.62
257	3	260	8.6	265	3.55	269	2	272.64	3.53	277	3
257	3.5	260	10	265	4	269	2.5	272.97	5.55	277	3.3
257	4	260	20	265	4.4	269	3	273	3.5	277	3.5
257	4.5	260.5	3.3	265	5	269	3.5	273	4	277	4
257	5	260.5	5.3	265	5.3	269	3.53	273	4.5	277	5
257.5	3	261	3.5	265	5.33	269	4	273	5	277	6
257.8	2.62	261	4	265	5.5	269	5	273	6	277	7.5
258	3	261	5	265	5.7	269	5.5	273	7	277.8	2.62
258	3.5	261	5.33	265	6	269	6	273	8	278	3
258	3.55	261.5	8	265	6.5	269	6.9	273	12	278	3.15
258	4	262	2	265	7	269	8	273	16	278	3.2
258	5	262	3.5	265	8	269	9	274	2	278	3.5
258	6	262	4	265	10	269.2	5.7	274	3	278	4
258	6.3	262	5	265.5	2.5	269.24	5.33	274	3.5	278	5
258	7	262	5.25	266	3.5	269.3	5.5	274	4	278	6
258	8	262	5.5	266	4	269.3	5.7	274	5	278	8
258	9	262	6	266	5	269.5	6	274	6.5	278	10
258	10	262	7	266	5.7	269.5	8	274	8	278	12
258	12	262	8	266	6	269.5	8.4	274	8.4	278.7	3.53
258	15	262	9	266	7	270	2.2	274	8.6	278.7	5.7
258.5	3.5	262	10	266	10	270	2.5	274.2	5.7	278.7	7.4
258.5	9	262	13	266	19	270	3	274.3	3.1	278.77	5.33
259	2.62	262	14	266.07	5.33	270	3.5	274.5	4	278.77	6.99
259	3	262.34	3.53	266.07	6.99	270	4	274.5	8.4	278.89	3.53
259	3.5	262.5	5.5	266.1	10	270	5	275	2.5	279	3
259	4	263	3.5	266.3	3.53	270	5.3	275	3	279	3.5
259	5	263	4	266.5	3	270	5.5	275	3.5	279	3.53
259	6	263	5	266.7	4.76	270	6	275	4	279	4
259	8	263	6.5	266.7	6.35	270	6.3	275	5	279	5
259	10	263.4	5	266.7	6.99	270	6.5	275	5.15	279	6
259	18	263.5	7	267	2	270	7	275	6	279	6.9
259.1	8.4	263.52	9.5	267	2.5	270	7.5	275	7	279	7
259.2	5.7	263.7	8.6	267	2.7	270	7.6	275	7.4	279	8.4
259.24	3.53	264	2.8	267	3	270	8	275	7.5	279.1	8.4
259.26	2.62	264	3	267	3.5	270	9	275	7.6	279.2	5.7
259.3	3	264	3.5	267	4	270	10	275	8	279.3	3.17
259.3	5.7	264	4	267	4.5	270	12	275	8.4	279.3	5.7
259.5	5	264	4.5	267	5	270	13	275	10	279.4	6.35

Dichtomatik dimensions

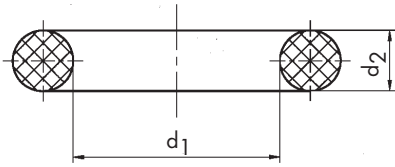

d1	d2	d1	d2	d1	d2	d1	d2
279.5	8.4	284.5	4	289.3	5.7	293	5.5
280	2.5	284.5	8.4	289.5	8.4	293	6
280	3	284.75	3.53	290	2	293	7
280	3.5	285	2.4	290	2.5	294	2.7
280	3.55	285	3	290	3	294	3
280	4	285	3.5	290	3.5	294	3.5
280	4.5	285	4	290	3.55	294	4
280	5	285	5	290	3.75	294	5
280	5.3	285	5.33	290	4	294	6
280	5.33	285	6	290	5	294	11.5
280	6	285	7	290	5.3	294	14
280	6.3	285	8.4	290	5.33	294	17
280	7	285	9.53	290	6	294	20
280	8	285	10	290	6.5	294.2	5.7
280	8.6	285	10.7	290	7	294.48	7
280	9	285	15	290	7.5	294.5	6
280	10	285	17	290	8	294.5	8.4
280	12	285.1	6.99	290	9	295	2
280	15	285.75	7.94	290	9.6	295	2.6
280	16	285.87	3.53	290	10	295	2.9
280	17	286	2.4	290	12	295	3
280	20	286	2.43	290	15	295	3.5
281	3.5	286	3.5	291	3	295	4
281	4	286	4	291	3.5	295	5
281	4.5	286	5	291	4	295	6
281	5	286	5.5	291	5	295	7
282	3.5	286	6	291	6.2	295	8
282	4	286	6.2	291.4	3.53	295	10
282	5	286	7	291.47	5.33	295	12
282	6	286	8	291.47	6.99	295	15
282	8	286	10	291.47	7.82	295	17
282	14	286.8	8	291.7	3.53	295	20
282.17	3.53	287	3.5	292	1.5	295.5	5
283	2	287	4	292	2.65	295.5	8.4
283	3.5	287	4.2	292	3	295.8	12.7
283	4	287	5	292	3.17	296	2.5
283	5	287	10	292	3.5	296	3
283	5.33	287	15	292	4	296	3.5
283.18	6.99	287	20	292	5	296	4
283.18	12.7	287.7	5.3	292	5.7	296	5
283.5	9	288	2.62	292	6	296	5.33
284	2.62	288	3.5	292	7	296	8.4
284	3.5	288	3.53	292	8	296	12
284	4	288	4	292	9	297	2.4
284	5	288	5	292	10	297	3
284	6	288	6	292	20	297	3.5
284	8	288	7	292.1	3.18	297	4
284	8.4	288	14	292.1	6.35	297	5
284	9	288	18	292.6	8.4	297	7
284	10	288.2	6	292.79	3.53	297	8.8
284	12	289	3.5	293	2.5	297.5	5
284	14	289	4	293	3	297.57	5.7
284.2	5.7	289	5	293	3.5	297.8	6.99
284.3	5.7	289	8.4	293	4	298	2.4
284.3	6	289.2	5.7	293	5	298	2.5

d1	d2	d1	d2	d1	d2	d1	d2	d1	d2	d1	d2
298	2.53	301	4.5	306	5	310	16	315	10	320	6
298	2.62	301	5	306	6	310.13	5.33	315	12	320	6.5
298	3.5	301	6	306	6.3	310.5	6.99	315	15	320	7
298	4	301.5	2.62	306	8	311	3.5	315	20	320	8
298	5	302	3.5	306.4	2.62	311	4	315.6	6.99	320	8.6
298	6	302	3.53	306.5	2	311	5	315.8	3.53	320	10
298	7	302	4	306.8	10	311	6	316	2.62	320	12
298	7.2	302	4.3	307	3.5	312	2.62	316	3.5	320	20
298	10	302	5	307	3.55	312	3	316	4	320.5	14
298	11	302	8	307	4	312	3.5	316	5	321	3.5
298	12	302	8.4	307	5	312	4	316	7	321	4
298	15	302	12.5	307	5.3	312	5	316	8	321	5
298.5	6.35	303	3.5	307	6.8	312	5.3	316	9	321	5.33
298.5	9	303	4	307	7	312	5.5	316	12	321	12.7
298.7	8.6	303	5	307	8.4	312	6.3	316.26	2.62	321	13
299	2.62	303	6	307	9	312	8	316.7	5.33	322	3.5
299	3.5	303	9.5	307	9.2	312	10	316.87	6.99	322	4
299	4	303.5	9	307	12	312	18	316.9	12.5	322	5
299	5	304	3	307.57	3.53	313	3	317	3.5	322	8
299	8.6	304	3.5	308	3	313	3.5	317	4	322	9
299.1	8.4	304	4	308	3.5	313	4	317	5	322	13
299.2	5.7	304	5	308	4	313	5	317	7	322.5	4
299.3	5.7	304	5.7	308	5	313	7	317	9	322.86	8.02
299.5	8.4	304	6	308	6	313	10	317.5	2.62	323	2.62
300	1	304	7	308	7	313.26	2.62	317.5	6.35	323	3.5
300	2	304	8	308	8	313.5	7	317.5	9.5	323	4
300	2.3	304	8.4	308	9	314	2.62	318	2	323	5
300	2.5	304	9.53	308.86	5.33	314	3	318	3	323	5.7
300	2.62	304.1	5.7	309	3	314	3.5	318	3.5	323	7
300	3	304.17	5.33	309	3.5	314	4	318	4	323	10
300	3.2	304.17	6.99	309	4	314	5	318	5	323.2	6.99
300	3.5	304.2	5.7	309	4.5	314	6	318	6.3	323.3	5.7
300	3.53	304.36	5.7	309	5	314	7	318	14	323.7	8.6
300	3.55	304.39	3.53	309.1	8.4	314	7.5	318.5	5	323.8	5
300	4	304.8	3.2	309.2	5.7	314	8	319	3.5	324	3.5
300	4.5	304.8	6.3	309.5	4.5	314	8.4	319	4	324	4
300	5	305	3	310	2	314	8.6	319	5	324	5
300	5.3	305	3.5	310	2.5	314	12	319	5.7	324	5.34
300	5.7	305	4	310	3	314.3	5.7	319	7	324	6
300	6	305	4.5	310	3.5	314.5	5.7	319	8.4	324	7
300	6.5	305	5	310	4	314.5	8.4	319	10	324	8
300	7	305	5.3	310	4.5	315	2.5	319.1	8.4	324	8.4
300	7.5	305	6	310	5	315	3	319.2	3.53	324	9.53
300	8	305	6.35	310	5.7	315	3.5	319.2	5.7	324	17
300	8.4	305	6.7	310	6	315	3.53	319.3	5.7	324.1	8.4
300	8.6	305	7	310	6.5	315	3.55	319.5	5.7	324.3	5.7
300	9	305	7.25	310	6.6	315	4	319.5	8.4	324.5	7.5
300	10	305	7.5	310	7	315	4.5	320	2	325	2.5
300	12	305	8	310	8	315	5	320	2.5	325	3
300	12.5	305	8.5	310	8.4	315	5.3	320	3	325	3.5
300	12.7	305	10	310	8.5	315	5.33	320	3.5	325	3.52
300	15	305	20	310	9	315	6	320	4	325	4
301	1.78	305.5	8	310	10	315	6.99	320	5	325	5
301	3.5	306	3.5	310	12	315	7	320	5.33	325	5.2
301	4	306	4	310	15	315	8	320	5.5	325	5.3

Dichtomatik dimensions

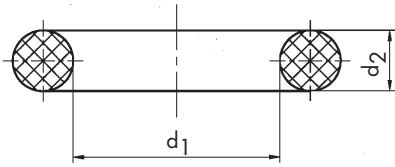

d1	d2	d1	d2	d1	d2	d1	d2
325	5.5	330	3.5	334.5	8.4	339	7
325	6	330	4	334.7	8.6	339	8.4
325	6.5	330	4.5	335	2.4	339	15
325	7	330	5	335	3	339.2	5.7
325	7.5	330	5.5	335	3.5	339.3	5.7
325	8	330	5.7	335	3.55	339.5	8.4
325	10	330	6	335	4	339.57	5.33
325	11	330	6.5	335	4.5	339.6	3
325	12.7	330	7	335	5	340	3
325	16	330	7.5	335	5.3	340	3.5
325.6	3.2	330	8	335	5.34	340	4
326	3	330	8.4	335	6	340	4.6
326	3.5	330	8.5	335	7	340	5
326	4	330	8.75	335	7.5	340	5.33
326	5	330	9	335	8	340	5.5
326	5.5	330	9.53	335	8.4	340	5.7
326	5.7	330	10	335	10	340	6
326	8	330	13	335	20	340	6.4
326	11	330	14	335.9	6.99	340	7
327	3.5	330	15	336	3.5	340	7.2
327	3.53	330	16	336	4	340	7.5
327	3.6	330	20	336	5	340	8
327	3.7	330.2	6.3	336	6	340	8.6
327	4	330.2	6.35	336	7	340	9.3
327	5	330.2	12.7	336	7.4	340	10
327	8	330.3	12.5	336	8	340	11
327	14	331	3	336	9.35	340	12
327.56	5.33	331	3.5	336	9.53	340	16
328	2.5	331	3.53	336	12	340.4	3
328	2.98	331	4	336.5	5.5	340.4	6
328	3	331	5	336.6	3.18	340.6	7.2
328	3.5	332	3	336.6	5.8	341	3.5
328	4	332	3.5	336.6	8	341	4
328	5	332	4	337	3.5	341	5
328	6	332	5	337	4	342	3
328	7.5	332	5.33	337	5	342	3.2
328	10	332	6	337	6	342	3.5
328	12	332	16	337	8	342	4
328.5	6	333	3.5	337.5	7	342	5
328.5	6.5	333	4	338	3	342	6
328.6	8	333	4.5	338	3.5	342	7
329	3.5	333	5	338	4	342	7.5
329	4	333	6	338	5	342	8
329	5	333	7	338	6	342.27	5.33
329	8	333	8	338	6.3	342.27	6.99
329.2	5.7	333	10	338	7	342.3	12.5
329.3	5.7	333	12	338	9	342.5	7.4
329.5	8.4	333.2	3.6	338	12	342.9	3.53
329.57	5.33	334	2.5	338	13	342.9	5.33
329.57	6.99	334	3.5	338.4	1.5	343	3.5
329.8	3.53	334	4	338.4	1.6	343	4
329.8	3.75	334	5	338.4	3.53	343	4.5
330	2	334	8	339	3.5	343	5
330	3	334.2	12.3	339	4	343	6
330	3.2	334.3	5.7	339	5	343	7

d1	d2	d1	d2	d1	d2	d1	d2	d1	d2	d1	d2
343	10	348	11	353	5	358	6	365	3	370	5.5
344	2.5	348	12	353	6	358	6.3	365	3.5	370	5.7
344	2.62	348.4	3.53	353	7	359	3.5	365	4	370	6
344	3	348.5	6	353	10	359	4	365	4.5	370	7
344	3.5	349	2.5	353.37	3.53	359	5	365	5	370	7.5
344	4	349	3	353.37	6.99	359	5.33	365	5.3	370	8
344	5	349	3.5	353.7	8.6	359	7	365	5.75	370	8.4
344	5.7	349	4	354	3	359	8	365	6	370	10
344	6	349	5	354	3.5	359	8.4	365	7	370	11
344	8	349	5.33	354	4	359.1	8.4	365	8	370	12
344	8.4	349	5.7	354	5	359.2	5.7	365	8.5	370	14
344	9	349	7.5	354	5.33	359.3	5.7	365	10	370	15
344	16	349.1	8.4	354	7.5	359.5	8.4	365.1	8.4	370.75	14
344	20	349.2	5.33	354	8	360	3	365.5	12.5	371	3.5
345	2	349.2	5.7	354.07	5.33	360	3.5	366	2.5	371	4
345	3	349.5	2.5	354.3	5.7	360	4	366	3.5	371	5
345	3.15	350	2	354.5	8.4	360	5	366	4	371	8
345	3.5	350	2.5	354.97	5.33	360	5.5	366	5	371	8.5
345	4	350	3	354.97	6.99	360	5.6	366	7	372	3.5
345	5	350	3.5	355	3	360	6	366	8	372	4
345	5.3	350	4	355	3.5	360	6.5	366	9	372	5
345	5.33	350	4.5	355	3.55	360	7	366.1	3	372	6
345	5.6	350	5	355	4	360	7.5	366.54	3.53	372	8
345	5.7	350	5.2	355	5	360	8	367	3	372	10
345	6	350	5.5	355	5.3	360	8.6	367	3.5	372	12
345	6.5	350	6	355	6	360	9	367	4	373	2
345	7	350	6.5	355	7	360	10	367	5	373	2.4
345	8	350	7	355	7.5	360	11	367	7	373	3.5
345	10	350	8	355	12	360	12	367	7.5	373	4
345	20	350	9	355	15	360	15	367	8	373	5
346	2	350	10	355	20	361	3.5	367	20	373	7
346	3	350	11	355.2	3.53	361	4	367.67	6.99	373	8
346	3.5	350	12	355.6	6.5	361	5	367.9	5.5	373.5	5
346	4	350	13	355.6	6.99	361	6	368	2.5	374	3.5
346	5	350	17	356	3.5	362	3	368	3.5	374	4
346	6	350	20	356	4	362	3.5	368	4	374	5
346	8	351	3.5	356	5	362	4	368	5	374	5.7
346	9.4	351	4	356	8	362	5	368	5.33	374	8
346	9.5	351	5	356.5	10	362	7	368	6	374	9.52
347	3.5	351	7	357	2.62	362	8	368	7	374	10
347	4	351	10	357	3	362	12	368	8	374	16
347	5	352	3	357	3.5	363	3	368	10	374.2	6.35
347	6	352	3.5	357	4	363	3.5	368.3	4.5	374.5	8.4
347	7	352	4	357	5	363	4	369	3.5	374.5	9.52
347	9	352	4.5	357	5.7	363	5	369	4	375	2.5
347	18	352	5	357	7.5	363	5.34	369	5	375	3
348	3	352	6	357	8	363	6	369	9	375	3.4
348	3.5	352	8	357	12	363	8	369.1	8.4	375	3.5
348	3.53	352	10	357.4	5	364	3.5	369.3	5.7	375	3.55
348	4	352	12	357.4	5.7	364	3.53	370	2.5	375	4
348	5	352.5	5.7	358	3	364	4	370	3	375	5
348	6	353	2.62	358	3.5	364	5	370	3.5	375	5.3
348	7	353	3	358	4	364	8.4	370	4	375	6
348	8	353	3.5	358	5	364.2	5.7	370	5	375	6.4
348	8.5	353	4	358	5.7	365	2	370	5.3	375	7

Dichtomatik dimensions

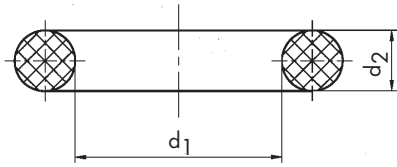

d1	d2	d1	d2	d1	d2	d1	d2
375	7.5	380	10	386.3	5.7	392	5
375	8	380	14	386.5	5	392	5.33
375	8.4	380	17	386.87	6.99	392	5.7
375	9	380	20	386.94	3.53	392	6
375	10	380.37	5.33	387	3	392	6.3
375	11	380.37	6.99	387	3.5	392	8
375	13	380.6	3.53	387	4	392.8	3
376	3	381	3.5	387	5	393	3
376	3.5	381	4	387	5.3	393	3.5
376	4	381	5	387	6.4	393	3.53
376	5	381	6.35	387	7	393	4
376	6	381	11.11	387	8	393	5
376	8	381.87	5.7	387	20	393	7
376	9.5	382	3	387.35	6.73	393.07	6.99
376	12	382	3.5	388	3.5	393.1	12.5
376	14	382	4	388	4	393.45	6.3
377	3.5	382	5	388	4.5	393.7	2.9
377	4	382	8	388	5	393.7	3.5
377	5	382	10	388	6	394	2.62
377	8	382	16	388	7	394	3.5
377	10	383	3	388	10	394	4
377	15	383	3.5	389	3.5	394	4.8
377.5	10	383	4	389	4	394	5
377.7	5.7	383	5	389	5	394	6
378	3	383	7.5	389	5.33	394	8
378	3.5	383	8.1	389	5.7	394	8.4
378	4	383	8.4	389	6	394	9
378	5	384	3.5	389	8	394	15
378	6	384	4	389.3	5.7	394.72	3.53
378	8	384	5	389.3	8.5	394.97	5.33
378	8.6	384	8	390	3	395	2
378	12	384	8.4	390	3.5	395	2.5
379	3.5	384	9.52	390	4	395	3
379	4	384	14.09	390	5	395	3.5
379	4.5	384.5	8.4	390	5.5	395	4
379	5	384.55	14.09	390	5.7	395	5
379	6	385	3	390	6	395	6
379.1	8.4	385	3.5	390	6.3	395	7
379.2	5.7	385	4	390	6.55	395	8
379.3	5.7	385	5	390	6.7	395	10
379.8	7	385	6	390	7	395	12
380	3	385	6.3	390	7.2	395	14
380	3.5	385	7	390	8	396	3.5
380	3.53	385	8	390	9	396	3.55
380	4	385	8.6	390	10	396	4
380	5	385	10	390	16	396	5
380	5.5	385	12.5	390	18	396	5.5
380	6	385	12.7	390.5	3.5	396	10
380	6.2	385.5	6	391	3.5	397	3.5
380	6.5	386	3.5	391	4	397	4
380	7	386	4	391	5	397	5
380	7.5	386	5	391	6.99	397	7
380	8	386	6	392	3.5	397	8
380	8.4	386	7.5	392	3.53	397	10
380	9	386	14	392	4	397	13

d1	d2	d1	d2	d1	d2	d1	d2	d1	d2	d1	d2
397.1	8.4	402	6	408	3.5	414	16	420	9	427	5.5
397.51	9.53	402	6.3	408	4	414.1	8.4	420	10	427	10
397.66	3.53	402	9	408	5	414.3	5.7	420	12.7	427	20
397.7	5.7	403	3	408	6	415	3	421	3.5	428	2.62
398	2.62	403	3.5	408	6.3	415	3.5	421	4	428	3.5
398	3	403	4	408	7.5	415	4	421	5	428	4
398	3.5	403	6	408	8	415	4.5	421	5.2	428	6
398	4	403	7	408	12	415	5	421.5	2.65	428	8
398	5	403.4	5	408.3	9.5	415	5.5	422	2	429	3.5
398	6	404	3	408.41	8	415	5.7	422	3	429	4
398	8	404	3.5	409	3.5	415	6	422	3.5	429	5.7
398	10	404	4	409	4	415	7	422	4	429	6
398	12	404	6	409	10	415	7.5	422	5.7	430	3
399	3.5	404	6.5	410	3	415	8.4	422	6	430	3.5
399	4	404	8	410	3.5	415	15	422	6.9	430	4
399	4.1	404	12	410	4	416	3.5	422	7.5	430	5
399	5	404.1	8.4	410	4.5	416	4	422.2	6.2	430	5.7
399	6	405	3	410	5	416	6	422.2	6.9	430	7
399.1	8.4	405	3.5	410	5.7	416	16	423	3.5	430	7.5
399.2	5.7	405	4	410	6	417	3.5	423	3.53	430	8
399.3	5.7	405	5	410	6.3	417	3.53	423	4	430	9
399.42	5.33	405	6	410	6.5	417	4	423	6	430	10
399.5	8.4	405	6.5	410	7	417	8	423	9	430	12
399.5	8.5	405	7	410	8	417.5	5.33	423	10	430	13
399.6	8.4	405	7.5	410	8.4	417.9	7	424	3	430	15
400	2	405	8	410	9	417.96	4	424	3.5	430	17
400	2.5	405	9.5	410	10	417.96	6.99	424	4	430	20
400	3	405	10	410	12	418	3.5	424	5	430.5	5.33
400	3.5	405	12	410	15	418	4	424	7	430.66	3.53
400	4	405	15	410	20	418	5.7	424	8.5	430.66	5.33
400	4.5	405	17	410.5	7	418	7	424	9.52	430.66	6.99
400	5	405	20	411	3.5	418	8	425	3	431	3.5
400	5.3	405.26	3.53	411	4	419	3.5	425	3.5	431	4
400	5.5	405.26	5.33	411.48	5.33	419	4	425	4	431	8
400	5.6	405.26	6.99	412	3.5	419	6	425	5	431	8.4
400	6	405.26	7.5	412	4	419	7	425	5.33	431.3	8.4
400	6.3	405.26	8	412	5	419	8.4	425	5.5	431.8	3.17
400	6.5	405.3	9.5	412	7	419	14	425	6	431.8	6.35
400	6.7	406	2.62	412	8	419.1	6.35	425	6.5	432	3.5
400	7	406	3	412	9	419.1	8.4	425	7	432	4
400	7.5	406	3.5	412	10	419.2	5.7	425	8	432	5
400	8	406	4	412.7	5.6	419.3	5.7	425	8.4	432	10
400	8.4	406	5	413	3.5	419.5	8.4	425	8.5	433	3
400	8.5	406	10	413	4	419.7	6.35	425	16	433	3.5
400	9	406.26	5.33	413	12	420	2.5	425.45	3.97	433	4
400	10	406.4	3.17	413.7	5.33	420	3	425.45	9.52	433	4.5
400	12	406.4	6.35	414	3.5	420	3.5	426	3.5	433	7
400	15	406.4	6.5	414	4	420	4	426	3.53	433.36	6.99
400	16	406.4	15.8	414	5	420	5	426	4	433.5	5.5
401	3.5	407	3.5	414	5.33	420	5.33	426	5.7	434	3.5
401	4	407	4	414	6.3	420	5.5	426	6	434	4
402	3.5	407	5	414	8.4	420	6	426	17	434	5
402	4	407	5.7	414	10	420	6.5	427	3.5	434	7
402	4.5	407	6.3	414	12	420	7	427	4	434	8
402	5.33	407	6.35	414	13	420	8	427	5	434	10

Dichtomatik dimensions

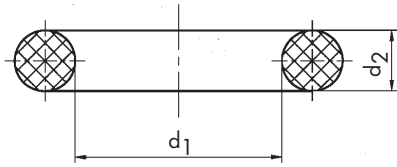

d1	d2	d1	d2	d1	d2	d1	d2
434.5	8.4	440	6.3	449	6	457	6.35
434.9	8.25	440	7	449	6.99	457	7
435	3	440	8	449.1	8.4	457	8
435	3.5	440	8.5	449.2	6.3	457	8.4
435	4	440	9	449.3	5.7	457	9
435	5	440	10	449.8	6	457	9.52
435	5.7	440	14	449.8	6.2	457.2	7
435	6	440	15	450	3	458	4
435	7	440	16	450	4	458	6
435	8	440	20	450	5	458	9
435	8.5	440.69	2.62	450	6	458	10
435	12	440.69	5.33	450	6.3	458	12
435	14	441	2.5	450	6.5	458.5	10
435	15.2	441	4	450	7	459	4
435	20	441	5	450	8	459.2	5.7
436	3	441	8	450	8.6	459.3	5.7
436	3.5	442	4	450	10	460	3
436	4	442	6	451	4	460	4
436	7	442	12	451	7	460	5
437	3.5	443	4	451	9	460	6
437	4	443	7	451	10	460	6.5
437	6	443.36	6.99	452	4	460	7
437	7	444	3	452	5.33	460	7.4
438	3	444	4	452	6	460	8
438	3.5	444	5	452	8	460	8.2
438	4	444	6	452	12	460	8.4
438	6	444	8	452.4	9	460	8.5
438	7.5	444	8.4	453	3.5	460	10
438	12	444.2	5.7	453	4	460	12
438	12.7	445	3.53	453	5.7	461	4
438	14	445	4	453	6	461	5
438.1	3.5	445	5	453	6.35	461	7
439	3	445	5.7	453	6.4	461	8.4
439	3.5	445	6	453.3	5.7	461	8.6
439	4	445	7	454	4	461.4	8.6
439	5.7	445	8	454	5	462	3
439	6	445	9	454	8	462	4
439	7	445	12	454	9.5	462	5.33
439.1	8.4	445	15	454	10	462	7
439.2	5.7	446	4	455	3	462	10
439.3	5.7	446	5.33	455	4	462	13
439.34	5.33	446	6	455	5	462	15
439.5	4	446	8	455	6	462.1	8.4
439.5	5.7	446	10	455	6.2	463	4
440	2	446	14	455	7	463	8
440	2.5	447	4	455	8.4	463	9.5
440	2.8	447	8	455	13	463.55	7
440	3	448	3	456	4	463.55	12.7
440	3.5	448	4	456	7	464	3.5
440	4	448	5	456	7.5	464	4
440	4.2	448	6	456.06	3.53	464	6
440	4.5	448	8	456.06	5.33	464	7.5
440	5	448	10	456.06	6.99	464	8
440	5.6	448	14	457	3	464	9
440	6	449	4	457	4	465	3

d1	d2	d1	d2	d1	d2	d1	d2	d1	d2	d1	d2
465	4	471	10	480	14	490	2	495	8	505	5.7
465	5	472	3.53	480	16	490	4	495	8.4	505	6
465	6	472	4	480	20	490	5	495	14	505	7
465	7	472	5	481	3.55	490	5.33	495.3	6.35	505	8
465	8.4	472	5.7	481	4	490	6	496	4	505	10
465	9	472	8	481	5.33	490	6.35	496	6	506	3.5
465	10	472	10	481	6	490	6.5	496	10	506	6
465.3	5.7	473	4	481	7	490	6.7	496	12	506	7
466	4	473	6.5	481	8	490	7	496.9	5.33	506	8
466	5	473	7.5	481	8.4	490	7.5	497	4	506.81	5.33
466.72	6.35	473.6	5.7	481.46	5.33	490	8	497	5.34	506.86	6.99
467	4	474	3	481.46	6.99	490	8.4	498	4	506.86	8
467	5.7	474	3.53	481.83	5.3	490	9	498	6.99	507	3
467	7.8	474	4	482	3.53	490	10	498	8	507	4
467	8.4	474	12	482	4	490	12	498.5	7.5	507	5
467	10	474.3	5.7	482	5	490	12.7	499	4	507	8.5
468	3.53	474.5	8.4	482	5.34	490	15	499	12	507	15
468	4	475	3	482	6	490	16	499.2	5.7	507.5	5.3
468	6	475	4	482.6	6.35	491	4	499.3	5	508	4
468	6.3	475	5	483	3	491	5.33	499.3	5.7	508	6
468	7	475	6	483	4	491.49	5.33	499.5	7	508	6.35
468	8	475	7	483	6	491.5	4	499.5	8.4	508	8
468.76	6.99	475	8	483	7	491.5	8.5	500	3	508	8.5
468.9	6.35	475	10	483	7.15	492	4	500	3.53	508	10
469	3	475	15	483	8.4	492	5.33	500	4	508	12
469	4	475.08	8.74	484	3	492	6	500	5	508.74	4
469	4.77	475.4	5	484	4	492	6.3	500	6	509	3.5
469	5.7	476	4	485	3	492	8	500	6.3	509.1	8.4
469	6.35	476	4.5	485	4	492	9	500	6.99	509.3	5.7
469	7	476	5	485	5	492	10	500	7	509.4	6
469.3	5.7	476	5.5	485	8	492.13	5.33	500	7.5	509.6	6
469.5	6.4	476	7	485	15	492.25	3.53	500	8	510	3
469.9	6.35	477	4	485.3	4.8	493	4	500	8.5	510	3.5
469.97	4.77	477	6.99	486	4	493	7	500	9	510	4
470	2.5	477	8	486	6	493	12.7	500	10	510	4.5
470	3	478	4	486	7	493.5	4	500	12	510	5
470	3.5	478	5	486	12	494	4	500	14	510	5.7
470	4	478	6	486	17	494	4.5	500	15	510	6
470	4.5	478	8	486	20	494	5.34	501	5	510	6.5
470	5	478	14	486.76	6.99	494	6	501.65	3.53	510	7
470	5.2	478	17	487	4	494	7	502	5.33	510	8
470	5.3	479	4	487	7	494	8	502	8	510	8.5
470	5.33	479.2	5.7	487	8	494.1	5.7	502	8.2	510	9
470	5.5	479.3	5.7	487	10	494.1	8.4	502	8.6	510	10
470	5.7	479.42	4.75	488	4	494.16	6.5	502	16	510	12
470	6	480	4	488	5	494.16	6.99	502.9	8.4	510	16
470	7	480	5	488	6	494.5	8	503	6	511.5	8
470	8	480	6	488	9	494.6	5.33	503	7.5	512	3
470	9.5	480	7	488	10	494.67	7	503	10	512	4
470	10	480	7.5	488.5	3	495	3	504	6	512	6
470	12	480	8	489	3	495	4	504	8	512	7
470.4	5.7	480	8.6	489	4	495	4.5	504.5	8	512	7.6
470.4	6	480	9	489	6	495	5	505	2.62	512	8
471	4	480	10	489.2	5.7	495	6.3	505	3	512	10
471	9	480	12	489.87	6.99	495	7	505	4	512	18

Dichtomatik dimensions

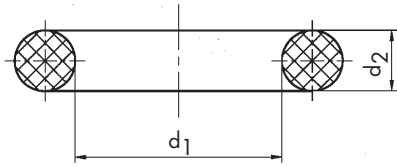

d1	d2	d1	d2	d1	d2	d1	d2
513	4	524	3	533.4	9.5	545.47	6.99
513	5.66	524.8	10	534	4	546	8
514	8	525	2.62	534	5.7	546	14
514	8.4	525	3	534	16	546	15
514	10	525	4	534.1	8.4	546.1	6.35
514	14	525	5	534.5	8.4	547	8
514.3	5.7	525	5.7	535	4	547	14
514.6	5.33	525	6	535	5	547.6	9.5
514.9	16	525	7	535	5.7	548	3.5
515	3	525	8	535	7	548	5.7
515	4	525	9	535	8	548	6.5
515	5	525	12	535	10	549	3
515	6	525.9	13	537	7	549	6
515	7	526	3.5	537	8	549	9.52
515	8	526	4	538	3	550	3
515	10	526	20	538	6	550	4
516	6	526.4	5.7	538	7	550	5
516	8	527	4.7	538	8	550	5.5
516	8.4	527	7	538	8.4	550	6
516	12	528	3	538	12	550	7
518	3	528	3.5	538.5	8	550	8
518	6.4	528	8	539	3.5	550	9
518	8	528	10	539	7	550	10
518.5	3	528	10.82	540	3	550	13
519	2.62	528	17	540	4	550	14
519	6	528.5	10.82	540	4.5	550	16
519	8	529	3	540	5	552	2.62
519.3	5.7	529	5.34	540	5.7	552	4
520	3.5	529.3	5.7	540	6	552	5.33
520	3.53	530	3	540	6.5	552	6
520	4	530	3.5	540	7	552	6.3
520	5	530	4	540	8	552	8
520	5.5	530	5	540	10	553	8
520	6	530	5.33	540	12	553	8.4
520	7	530	6	540	20	553.34	6.99
520	8	530	6.5	541	14	554	3.8
520	9	530	7	542	7	554	4
520	10	530	8	542	8	554	5
520	12	530	9	542	10	554	5.33
520.06	6.99	530	9.5	542.9	8.4	554	7
520.06	7	530	9.55	543	3.5	554	10
520.5	9.98	530	10	544	6	554	12
520.5	15	530	12	544	6.5	554.3	5.7
520.7	6.35	531	7	544	8	555	3.53
521	5.33	531	8	544	16	555	5
522	3	532	4	544.3	5.7	555	6
522	6	532	6.5	545	3	555	6.2
522	7	532	7	545	4	555	6.35
522	8	532	8.4	545	5	555	7
522	8.4	532	10	545	5.7	555	9
522	8.7	532.2	5.33	545	7	555	10
522	9.5	532.26	6.99	545	8	555	11.5
522	10	533	6	545	9	555	12
523	5	533	7	545	12	556	8
523	7	533	8	545	15	556	10

d1	d2	d1	d2	d1	d2	d1	d2	d1	d2	d1	d2
556	18	568	4.4	580	3.53	589	5	600	7	612	10
557	5.33	568	4.5	580	4	589	10	600	8	613	5.33
557.61	5.33	568	5	580	4.5	589	12	600	8.2	613	5.7
557.66	6.99	568	6	580	5	590	3	600	9	613	6.35
558	3	568	7	580	5.33	590	3.53	600	10	614	7
558	4	568	8	580	5.7	590	4	600	11	615	5
558	5.7	568.5	10	580	6	590	4.5	600	12	615	5.3
558	6.3	568.6	8.4	580	7	590	5	600	16	615	5.8
558	7	569	6	580	8	590	6	601	7.5	615	6
558	10	569	7	580	9	590	7	601.5	9.5	615	7
558.5	8.5	569.27	6.99	580	10	590	8.5	603	10	615	8.4
558.8	4	569.6	8.7	580	12	590	9	604	7	615	10
559.1	6.35	570	3	580	18	590	15	605	5	615	12
559.6	12	570	3.53	581	3.53	590	15.88	605	5.7	616	6
560	3	570	4	581	16	590	16	605	8.4	616	15.6
560	4	570	5	582	7	591	8	605.9	6.35	617	7
560	4.35	570	5.7	582	8	592	8	606	3	618	3
560	4.5	570	6	582	12	592	8.6	606	3.53	618	7
560	5	570	7	582	12.7	593	4	607	3	618	8
560	6	570	8	582	14	594	5.7	607	5	618	12.7
560	6.3	570	8.4	582.68	5.33	594	8	607	7	618	14
560	7	570	9.5	582.68	6.99	594	15	608	6	618	18
560	8	570	10	583	6.7	594.51	7.14	608	6.4	619	7
560	8.2	570	12	583	7	595	5	608	7	620	4
560	8.4	570.65	8.4	583	12	595	6	608	8.4	620	5
560	9.6	571	5	584	6.5	595	8	608	9	620	6
560	10	571	6.35	584	7	595	10	608	10	620	7
560	12	571	10	584	8.4	595	12	608	11	620	8
561	5	571.5	5	584	20	595	14	608.08	5.33	620	9
561	8	571.5	6.35	584.1	8.4	595	16	608.08	6.99	620	10
561	8.5	572	4	584.2	9.52	596	7	608.5	10	620	12
561.5	8.5	572	5.33	585	4	596	8	608.8	5.33	620	15
561.5	9	572	10	585	5	596	9	608.88	6.99	621	7
562	4	572.4	9	585	6	596.27	6.99	608.9	9	621	8
562	7.5	574	5.34	585	6.3	596.6	16	609	8	621	9
563	3	574	7	585	7	596.75	5	609.5	8	622	5.33
563	7	574	10	585	7.5	597	4.48	609.6	12.7	622	7
564	5.33	575	5	585	8	597	4.5	610	3.5	622	8
564	6	575	6	585	9.55	597	7	610	4	622	9
564	8	575	6.5	585	10	597.03	5.33	610	5	622.3	5.7
565	5	575	7	585	16	598	5.5	610	5.33	622.3	15.88
565	5.3	575	8	586	5.7	598	6	610	5.7	623	8
565	5.7	576	6	586	6	598	8	610	6	623	9
565	6	576	7	586	7	598	12	610	6.35	624	5
565	7	576	8	586	7.5	599	7.3	610	6.4	624	5.4
565	8	577	7	586	8	599.3	5.7	610	6.5	624	6.99
565	8.4	577	20	586.5	10	599.4	7.3	610	7	624	8
565	10	577	21	587	6	599.6	14.4	610	7.5	624	17
565.9	7	577.85	6.99	587	10	600	3	610	8	625	3
566	6.35	578	12	588	6	600	3.53	610	10	625	5
566	9	578	17	588	6.3	600	4	610	12	625	5.33
567	3	579	6	588	6.35	600	5	610	16	625	6
567	20	579	8	588	7	600	5.7	612	4	625	6.35
567.4	5.33	579.3	5.7	588	8.4	600	6	612	7	625	7
568	4	580	3	589	3.53	600	6.5	612	8	625	8.4

Dichtomatik dimensions

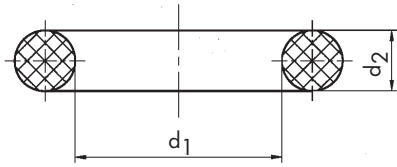

d1	d2	d1	d2	d1	d2	d1	d2
625	10	640	8	656	6	669	13.2
626	7	640	9	656	7.9	669	18
628	5	641	8.6	656	8	669.5	5.6
628	7	641.6	8.7	657	8.4	670	3
628	9.05	642	3.53	658	5.7	670	4
628.5	7	642	5.7	658	6	670	5
629	3	642	8	658	7	670	6
629	5.7	643	5	658	8.2	670	7
629	6	643	8.4	658.54	5.33	670	8
629.3	5.7	643.9	8.4	658.6	8.2	670	8.4
630	3.5	644	10	658.88	5.33	670	10
630	4	644	11	658.88	6.99	671	10
630	5	645	5	658.9	7.3	671	15
630	6	645	6	659	7	672	4
630	6.3	645	7	659	9.52	672	10
630	7	645	8	660	3	672	16
630	7.2	645	10	660	3.5	673.1	3.53
630	8	646	8.4	660	4	673.5	8.2
630	8.4	647.07	7	660	5	674	5.7
630	10	647.7	5.33	660	5.3	675	5.33
630.6	8.2	647.7	6.99	660	5.33	675	7
631	9	648	5	660	5.7	675	8
632	3	648	5.3	660	6	675	15
632	8	648	6	660	7	675.16	6.99
632	12	648	7	660	8	676	8
633	6	648	8	660	9	678	10.82
633	7	648	8.4	660	10	679	5.33
633.48	5.33	648	15	660	12	679.5	3.53
633.48	6.99	649	8.4	660	12.7	679.5	5.33
634	6	650	3	660	13	680	3
634	7	650	3.53	661	10	680	4
635	5	650	4	661	14	680	5
635	5.1	650	5	662	6.9	680	5.33
635	5.7	650	5.7	662	8	680	6.3
635	6	650	6	663	5.4	680	7
635	6.35	650	6.7	663	6	680	7.3
635	7	650	7	663	8.8	680	8
635	7.3	650	8	664	10	680	8.2
635	8	650	9.5	665	5	680	8.4
635	8.4	650	10	665	5.33	680	9
635	9.5	650	11	665	5.7	680	10
635	10	650	12	665	6	680	11.5
635	12.7	650	15	665	6.35	680	12
636.9	3.53	650	20	665	7	680	15
637	10	651	4	665	8.4	680.6	8.2
638	4	651	7	665	12	681	7.5
638	4.9	651.5	11.5	665	16	681	8.2
638	6	652	6	665.18	5.33	682	6
639	4	652	9.5	665.4	6	682	7.5
640	3	653	4	666	9	682	8
640	4	653	8	667	6	683	5
640	5	654	6	667	7	683	8
640	6	654	18	668	6	683	10
640	6.3	655	4	668	7	684	6
640	7	655.34	5.33	668	12	684	7

d1	d2	d1	d2	d1	d2	d1	d2	d1	d2	d1	d2
685	3	700	12	720	4	734	7	750	7	770	7
685	4	700	13	720	5	735	5	750	7.5	770	8
685	5.34	700.4	14.8	720	6	735	6	750	8	770	8.2
685	5.7	701.8	3.53	720	6.3	735	6.35	750	8.4	770	8.3
685	6.3	701.8	7	720	6.5	735	8	750	9	770	8.4
685	6.99	702	3	720	7	736	5	750	10	770	10
685	7	702	8.6	720	8	736	7	750	15	770.3	8.4
685	20	702	20	720	10	736	9.5	751	7	771	8.5
686	3.5	702.66	5.33	720	12	736.6	5.33	752	5	771.5	8.5
686	7	703	10	722	8	736.6	6.99	752	6	774	8.4
686	8	704	10.8	722	16	736.6	8	752	7	774	20
687	6.35	704.9	13.97	723	6	736.6	9.52	752.5	8.4	774.1	8.4
687	7	705	5	723	7	737	5.33	754	7	775	5.33
688	6	705	5.3	723.9	12.7	737	7.3	754	8	775	8
690	3	705	5.33	724	5.7	737	9.5	754.5	8.4	775	8.4
690	4	705	6	724	7	738	10	755	5	775	16
690	5	705	7	724	12	738	10.25	755	5.34	776	7
690	5.33	705	8	725	3.53	738.5	8.2	755	7	778	3
690	6	705	14	725	4	739	3	755	8.4	779	10
690	7	705.6	8.2	725	5	740	4	756	7	779.46	5.33
690	7.5	707.54	6.99	725	5.33	740	5	757	3	780	5
690	8	708	4	725	5.7	740	5.3	757	7	780	5.7
690	8.4	708	6	725	6	740	6	758	6	780	6
690	9	708	7	725	6.99	740	6.3	758	8	780	7
690	10	710	3	725	7	740	6.35	758	12	780	7.5
691	8	710	4	725	9	740	7	758	12.7	780	8
692	5.34	710	5	725	10	740	8.4	758.8	7	780	8.4
692	7	710	5.7	725	17	740	9	758.83	13.97	780	9
694	6	710	6	726	7	740	10	759	5.7	780	10
694	7	710	7	726	12	740	12	760	5	780	11
694	10	710	8	726	13	740	20	760	5.33	780	12
695	6	710	8.4	726.6	12	741.5	10	760	5.9	780.47	5.34
695	8	710	9	727	8	742	7	760	6	782	6.99
695	8.4	710	10	728.98	13.97	742	8.4	760	7	782	9
695	10	710	12	729	7	742	10	760	8	782	10
696	7	712	10	730	3.53	742	20	760	8.4	783	10
697	4	712	11	730	4	742.9	6.99	760	10	784	7
697	12	713	7	730	5	743	3.5	760	12	784	8.5
698	7	714	8	730	5.7	743	7	760	14	785	3
699	7	714.3	5	730	7	743	8	761	8	785	5
700	3	715	5.7	730	8	743.3	5.7	762	5	785	6.35
700	4	715	8	730	8.2	744	8	762	6.35	785	7
700	4.15	715	8.4	730	8.4	745	6.35	762	15	785	8
700	5	715	10	730	9	745	7	763	6.99	785	8.4
700	5.3	716	5.3	730	10	745	8.4	763	7	785	10
700	5.7	716	7	730	12	745	10	764.3	5.7	785	16
700	6	717	10	730	16	748	3	765	7	785	20
700	6.3	718	5.4	730.4	13.97	748	5.33	765	12	786	6
700	6.35	718	6	730.5	7	749	3	766	5.33	786	7
700	7	718	8	731	7	749	5.7	766	7	786	10
700	7.3	718	9.5	731	10	750	3.53	767	10	787	7
700	8	719	3	731.32	6.99	750	4	767	19	787	8.4
700	8.4	719	6.9	731.52	7	750	5	768	8.4	788	6
700	9	719	12	732	9	750	5.33	769.3	5.7	789	10.82
700	10	719.3	5.7	732.4	8	750	6	770	4	790	5

Dichtomatik dimensions

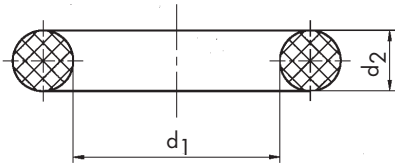

d1	d2	d1	d2	d1	d2	d1	d2
790	5.33	815	8	840	4	864	3.2
790	5.7	815	10	840	4.5	864	5
790	6.5	816	5	840	5	864	10
790	8	817	8.4	840	6.35	865	3
790	10	818	12	840	7	865	6
790.3	8.4	819.3	5.7	840	8	865	8
791	10	819.87	7	840	9	865	8.4
792	8	820	3.53	840	10	865	9
792	20	820	5	840	12	865	10
793	12	820	5.33	840	20	865	12
794	3.53	820	6	840	25	865	14
794	7	820	6.3	842	7	865.8	16.5
794	8.4	820	7	843	7	867	7
795	5.33	820	8	843	10	868	10
795	7	820	9	844	3	869.3	5.7
797.3	5.7	820	10	844	7	870	5
798	4.2	820	12	844.2	5.7	870	6
798	5.7	820	20	845	2.5	870	8
799	8.4	822	5	845	7	870	10
799	12	822.5	8.4	845	8	870	12
799.5	8.4	825	5.33	845	8.4	872	5
800	3.53	825	8	845	10	874	3
800	4	825	9	846	7	874.5	8.4
800	5	825	10	846	8	875	4
800	5.33	825	20	847	5.34	875	5.33
800	5.7	826	6	850	3	875	6.99
800	6	826	7	850	4	875	8
800	7	828	6	850	5	875	10
800	8	828	7	850	6	876	7
800	8.4	829	8	850	7	880	5
800	9	829	10	850	8	880	7
800	10	830	4	850	8.4	880	8
801	3	830	5	850	9	880	8.4
802	15.6	830	5.33	850	10	880	10
804	6.35	830	6	850	14.5	881	7
804	8	830	7	850	15	882	3
804.2	5.7	830	8.4	850	20	882	6.35
805	5.33	830	9	853	5.33	882	7
805	20	830	10	854	5.7	882	10
806	6	831	3	854	7	882.6	6.35
806	6.99	834	6.5	854	15.9	883	3
806	10	834	10.5	855	6	883	12
809	3.1	835	5.3	855	7	885	4
809	5	835	5.34	855	8	885	5.5
809.63	7	835	8	855	10	885	8
810	6	835	10	858	16.5	885	8.4
810	7	835	12	860	3	886	7
810	8	836	5.7	860	5.34	887	7
810	8.4	836	7	860	6.99	888	8.4
810	9	837	9.5	860	7	889	8
810	10	837	10	860	8	889.2	5.7
813	12	838	5	860	10	890	3.53
814	5.33	838	6	860	12	890	5
815	5	838.2	9.52	860	20	890	5.3
815	6	839	5.7	863	7	890	5.34

d1	d2	d1	d2	d1	d2	d1	d2	d1	d2	d1	d2
890	5.7	922	7	960	7	1002	3.53	1045	5.33	1100	5
890	6	925	5.33	960	8.4	1003	6.99	1045	5.7	1100	6
891	17	925	7	960	10	1003.6	8.4	1046	7	1100	7
892	8	925	8	961	12	1005	6	1046	12	1100	8.4
894	3.53	925	10	963	6.35	1005	9.52	1047	14.8	1100	9
894	12	926	5.34	963	10	1005.85	9.52	1050	7	1100	12
894	13	927	3	964.3	5.7	1006	5.33	1050	8	1100	20
894	14	927	6	965	5	1010	3.53	1050	9	1102	5.33
895	3.53	927	8	965	7	1010	5	1050	10	1108	10
895	4	930	5	965	7.14	1010	5.3	1051	5.34	1110	3.53
895	6	930	6	965	8	1010	6.99	1052	6	1110	6.99
895	8	930	7	965	10	1010	7	1054	10	1110	9
895	8.4	930	9	968	7	1010	8	1056	12	1112	7
895	12	930	10	968	12	1010	9	1057	5	1112	8.4
900	5	932	12	969	6	1010	10	1060	5.34	1113	7
900	5.33	932.54	6.99	970	5.33	1012	9	1060	8	1114	8.4
900	6.35	933	7	970	7	1013	6	1060	8.4	1116	12
900	7	934	8.4	970	10	1013	7	1060	10	1120	4.76
900	7.5	935	8	975	5	1014	5.34	1060	11	1120	6.35
900	8	935	10	975	5.33	1014	8	1062	5.5	1120	6.99
900	9	935	20	975	6	1014	8.4	1062	6	1120	8.4
900	10	936	9.52	975	6.99	1014	9.5	1065	8.4	1120	10
902	4	936	10	975	7	1015	8	1065	10	1122	5
902.6	3	938	7	975	8	1016	6.35	1066	5.33	1125	5.33
904	6.99	939.3	5.7	977	7	1016	7	1067	16	1125	8
904	7	940	5	980	5	1016.4	12	1068	8	1125	14.8
905	3.53	940	6	980	8	1017	5	1070	7	1125	15
905	10	940	6.35	980	9	1019	5.7	1070	12	1127.6	8.4
906	7	940	10	980	10	1020	4	1071	6	1129	5.7
907	5.33	940	12	980	12	1020	8	1071	7	1130	5
910	5	941	3	980	16.5	1020	10	1075	5.33	1130	5.7
910	6.5	944	7	981	11	1023	7	1075	5.7	1130	7
910	8	945	7	982	3	1023	15	1075	8.4	1130	8
910	8.4	945	10	983	7	1024	7	1075	20	1130	9
910	10	950	3	984	3	1025	5.33	1077	6.99	1130	10
910	12	950	5	985	8.4	1025	12	1080	5.33	1134	8.4
913	6	950	6	985	16	1026	3	1080	7	1135	5.34
914	3.2	950	7	987	8	1026	6.99	1080	8	1135	8
914	9.52	950	8	987	10	1027	12	1080	9	1139	5.37
914.4	6.35	950	10	988	5.33	1029	6.35	1080	10	1140	7
914.4	9.52	950	20	988	7	1030	5.7	1082	5	1140	12
915	6	952	7	990	6.35	1030	8	1082	5.34	1142	7
915	8.4	952.5	7	990	8	1030	9	1085	7	1142	8
915	10	953	7	990	9	1030	10	1085	12	1143	6.35
916	7	954	4	990	12	1030	13	1088	12	1145	8.4
918	5.7	955	9	992	8	1030	13.7	1090	6	1145	10
918	6	955	10	995	7	1030	14	1090	6.99	1145	19.8
918	12	956	3.53	1000	3	1033	12	1090	8	1150	4
920	4	956	7	1000	6	1035	10	1090	9	1150	7
920	6	957	3	1000	7	1036	9	1090	10	1150	8
920	7	957	5.34	1000	8	1038	10	1090	12	1150	8.4
920	8	957	7	1000	8.4	1040	5.33	1094.3	5.7	1150	10
920	8.5	957	20	1000	10	1040	7	1095	4	1150	16
920	10	958	10	1000	12	1040	10	1095	8	1151	12
920	12	959	8.4	1000	15	1044	8	1098	6.35	1155	6.35

Dichtomatik dimensions

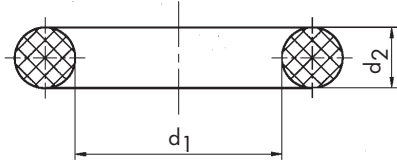

d1	d2	d1	d2
1157	5.33	1320	10
1160	5.7	1325	10
1160	8	1340	8
1160	9	1350	6
1160	10	1350	10
1164.5	5.33	1350	12
1165	10	1368.42	6.99
1170	5.5	1370	5
1170	7	1370	10
1170	10	1375	6
1172	5	1380	7
1172	5.7		
1175	5		
1175	15		
1180	7		
1180	8		
1180	8.4		
1185	7		
1185	8		
1185	12		
1190	7		
1192	10		
1195	8		
1209	6.35		
1210	8		
1220	5		
1220	10		
1225	8		
1226	7		
1230	7		
1235	15		
1240	8.4		
1240	10		
1246	8		
1250	10		
1260	5		
1260	6.35		
1260	10		
1260	12		
1265	7		
1268	5		
1270	6		
1270	10		
1280	10		
1286	14		
1290	7		
1290	10		
1295	15		
1300	6		
1300	10		
1300	15		
1305	8		
1307.5	6		
1320	7		
1320	8		



Germany
DICHTOMATIK GMBH

Albert-Schweitzer-Ring 1
D-22 045 Hamburg
P.O. Box 70 04 80
D-22 004 Hamburg
Phone 040/66 98 90
Fax 040/66 98 91 01
mail@dichtomatik.de
www.dichtomatik.de

Sweden
DICHTOMATIK AB

Hjalmar Brantings Väg 25
S-26143 Landskrona
Box 142
S-26122 Landskrona
Phone 0418/44 98 00
Fax 0418/44 98 20
mail@dichtomatik.se
www.dichtomatik.se

The Netherlands
DICHTOMATIK B.V.

Benjamin Franklinstraat 6
NL-8013 NC Zwolle
Postbus 40 102
NL-8004 DC Zwolle
Phone 038/46 01 606
Fax 038/46 71 900
mail@dichtomatik.nl
www.dichtomatik.nl

Italy
DICHTOMATIK S.R.L.

Via Delle Fabbriche 6
I-16158 Genova-Voltri
Phone 010/612 75
Fax 010/613 38 61
mail@dichtomatik.it
www.dichtomatik.it

Great Britain
DICHTOMATIK LIMITED

Donington House
Riverside Road
Pride Park
Derby DE24 8HX
Phone 01332/52 44 00
Fax 01332/52 44 04
mail@dichtomatik.co.uk
www.dichtomatik.co.uk

France
DICHTOMATIK S.A.S.

Espace Entreprises
Mâcon Loché TGV
F-71000 Loché
Phone 03/85 27 02 80
Fax 03/85 35 69 37
mail@dichtomatik.fr
www.dichtomatik.fr

Austria
DICHTOMATIK HANDELSGES. MBH

Rautenweg 17
A-1220 Wien
Phone 01/259 35 41
Fax 01/259 35 41 31
mail@dichtomatik.co.at
www.dichtomatik.co.at

Hungary
DICHTOMATIK KFT.

Üllői UT 288
H-1184 Budapest
Phone 01/297 43 45
Fax 01/297 02 18
szimering@elender.hu
www.dichtomatik.de

The technical details in this catalogue are based on experience and standard tests repeated in quality assurance and are to be seen as general and non-binding approximate values which may well vary up or down. We therefore recommend that you consult our technical department for concrete cases in which limits may be reached.

The catalogue details may be altered without notice. Upon the publication of a new catalogue, previous editions cease to be valid.

Reproduction in any form requires the express consent of Dichtomatik GmbH.