

**FAG****UC203**

Radial insert ball bearing

Materiálové číslo Schaeffler:
0767225380000

Radial insert ball bearings UC, spherical
outer ring, location by grub screws, RSR
seals on both sides

Technické informace

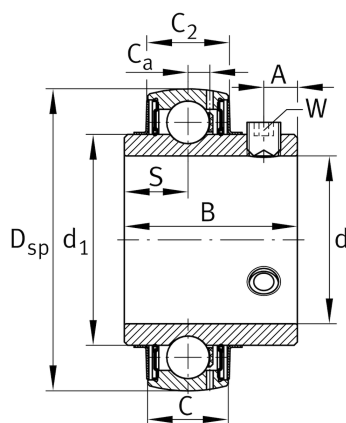
**Main Dimensions & Performance Data**

d	17 mm	Bore diameter
D _{SP}	47 mm	Outside diameter
B	31 mm	Width
C _r	13.600 N	Basic dynamic load rating, radial
C _{0r}	6.600 N	Basic static load rating, radial
C _{ur}	345 N	Fatigue load limit, radial
	0,185 kg	Hmotnost

Dimensions

C	17 mm	Width, outer ring
C ₂	16,8 mm	Sealing total width
S	12,7 mm	Distance raceway
d ₁	27,56 mm	Rib diameter inner ring
C _a	4,2 mm	Distance to lubrication hole
A	5 mm	Distance thread
W	3 mm	Width of flats

Calculation factors

f ₀	13,1	Calculation factor
----------------	------	--------------------